

INSTRUCTION MANUAL

Serial Number _____

BUSINESS REPLY MAIL

No postage necessary if mailed in the United States

Postage will be paid by

**TEKTRONIX, INC.
Dept. A
P. O. Box 500
Beaverton, Oregon 97005
U.S.A.**

FIRST CLASS
PERMIT NO. 61
BEAVERTON, OREGON

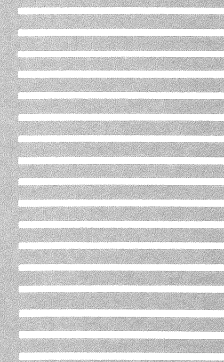

**3S7/3T7
TDR SYSTEM**

WARRANTY

All Tektronix instruments are warranted against defective materials and workmanship for one year.

Any questions with respect to the warranty, mentioned above, should be taken up with your Tektronix Field Engineer or representative.

All requests for repairs and replacement parts should be directed to the Tektronix Field Office or representative in your area. This procedure will assure you the fastest possible service. Please include the instrument Type (or Part Number) and Serial or Model Number with all requests for parts or service.

Specifications and price change privileges reserved.

Copyright © 1971 by Tektronix, Inc., Beaverton, Oregon. Printed in the United States of America. All rights reserved. Contents of this publication may not be reproduced in any form without permission of the copyright owner.

U.S.A. and foreign Tektronix products covered by U.S. and foreign patents and/or patents pending.

TABLE OF CONTENTS

	Page
SECTION 1	SPECIFICATION
	Introduction 1-1
	Electrical Characteristics 1-1
	Physical Characteristics 1-3
	Environmental Characteristics 1-3
SECTION 2	OPERATING INSTRUCTIONS
	General Information 2-1
	Front Panel Controls, Connectors, and Indicators 2-1
	Time Domain Reflectometer Installation 2-2
	Mating the Time Domain Reflectometer to the Oscilloscope 2-3
	First Time Operation
	Introduction 2-3
	Measurement Procedure 2-3
	Front Panel Adjustments
	Rho Cal Adjustment 2-4
	Preset Calibration 2-4
	Sampling Rate Adjustment 2-4
	Operation Information
	Time-Distance Scales 2-5
	Time-Distance Multiplier and Magnifier Operation 2-5
	Time and Distance Measurement Procedure 2-5
	Coupling Capacitor Usage 2-5
	Air Line Usage 2-6
	Long Transmission Line Measurement 2-6
	Voltage Reflection Coefficient (Rho) Measurement 2-6
	Synchroscope Applications 2-6
SECTION 3	CIRCUIT DESCRIPTION
	Time Domain Reflectometry 3-1
	Block Description 3-1
	Detailed Description
	Sampler Circuits 3-3
	TDR Sweep 3-4
	Scan Reset Operation 3-8
	Automatic Pulser Bias Adjust 3-9
	Locate Circuit 3-10

CONTENTS (cont)

	Page
SECTION 4 MAINTENANCE	
Introduction	4-1
Preventive Maintenance	
General	4-1
Cleaning	4-1
Lubrication	4-1
Visual Inspection	4-1
Calibration	4-1
Maintenance Information	
Switch Wafer Identification	4-1
Parts Replacement	4-1
Circuit Boards	4-2
Soldered-in Component Replacement	4-2
Leadless Capacitor Replacement	4-2
Troubleshooting Techniques	4-2
Resistor Color Code	4-3
Capacitor Marking	4-3
Diode Color Code	4-3
Wiring Color Code	4-3
Semiconductor Lead Configuration	4-4
Gate Diodes Replacement	4-4
Capacitor C18 Replacement	4-4
Vertical Board Removal and Replacement	4-4
Removal of Vertical Board Shields	4-6
Vertical Board Shields Replacement	4-6
Pulser Removal and Replacement	4-6
Pulser Shield Removal	4-6
Pulser Shield Replacement	4-6
Tunnel Diode Removal and Replacement	4-7
SECTION 5 PERFORMANCE CHECK	
Introduction	5-1
Recommended Equipment	5-1
Performance Check Procedure	
General	5-1
Preliminary Procedure	5-2
System Checks	5-2

CONTENTS (cont)

	Page
SECTION 6 CALIBRATION	
Introduction	6-1
Recommended Equipment	6-1
Calibration Procedure	
General	6-1
Preliminary Procedure	6-1
3T7 TDR Sweep Calibration	6-2
3S7 TDR Sampler Calibration	6-7
SECTION 7 ELECTRICAL PARTS LIST	
Abbreviations and Symbols	
Parts Ordering Information	
Index of Electrical Parts List	
Electrical Parts List	
SECTION 8 DIAGRAMS	
Symbols	
Component Locations	
Troubleshooting Waveforms	
Diagrams	
SECTION 9 MECHANICAL PARTS LIST AND ILLUSTRATIONS	
Mechanical Parts List Information	
Index of Mechanical Parts Illustrations	
Mechanical Parts List	
Standard Accessories	
Repackaging Information	
CHANGE INFORMATION	
Abbreviations and symbols used in this manual are based on or taken directly from IEEE Standard 260 "Standard Symbols for Units", MIL-STD-12B and other standards of the electronics industry. Change information, if any, is located at the rear of this manual.	

SECTION 1 SPECIFICATION

Change information, if any, affecting this section will be found at the rear of this manual.

Introduction

The Time Domain Reflectometry System is composed of the 3S7 TDR Sampler, the 3T7 TDR Sweep and the indicator oscilloscope. The 3S7 and 3T7 are used with the Tektronix Type 561A, 561B, 564, 564A, 564B, 567, or 568 Oscilloscope. The system's primary use is to measure impedance characteristics of transmission lines. The system also may be used as a sampling synchroscope having a band-pass of about 5 GHz in a 50 Ω environment.

The 3S7 TDR Sampler measures millivolts or millirho (voltage reflection coefficient) with deflection factors of 5 to 500 units/div in a 1-2-5 sequence. The display amplitude may be decreased by the VARIABLE control. A POLARITY switch permits inversion of the waveform. A DC OFFSET control range of +1 V to -1 V allows the observation of small signals superimposed on a DC voltage. A RESOLUTION switch permits reducing the displayed noise. A VERT SIG OUT jack provides a reproduction of the CRT display for a real-time oscilloscope or pen recorder drive. The POSITION lights indicate direction of vertical displacement of the off-screen display.

The 3T7 TDR Sweep Time-Distance controls and scales permit the measurement of the time or distance from one

end of a line under test to a displayed line discontinuity. The maximum time readout is 10 μ s. The maximum distance readout is 4920 feet for air dielectric and 3240 feet for polyethylene dielectric. Distances for transmission lines having a velocity of propagation between those of air and polyethylene may be measured when the PRESET is used and calibrated on the POLY scale. A time/div switch selects the units/div in a 1-2-5 sequence from 100 ps to 1 μ s. A VARIABLE control permits reduction in the horizontal display. A LOCATE button reduces the display magnification and shows the relative location of the time window as an intensified portion of the trace. The SCAN MODE switch selects the following modes of operation: SINGLE SWEEP, REPETITIVE, MANUAL (scan) and EXTERNAL (sweep input). The SWEEP OUT jack provides a ramp output which has 1 V amplitude for each division of horizontal display.

ELECTRICAL CHARACTERISTICS

The following characteristics apply over an ambient temperature range of 0°C to +50°C. All equipment used in checking these characteristics must be given sufficient warm-up time. Warm-up time for the system (3S7/3T7 and indicator oscilloscope) is 5 minutes.

ELECTRICAL CHARACTERISTICS

Characteristic	Performance Requirement	Supplemental Information
System Reflection Risetime	140 ps or less	
System Aberrations	+4%, -6% or less, with a total of 10% or less P-P, within 4 ns after pulse edge. +2%, -2% or less, with a total of 4% or less P-P from 4 ns after pulse edge and beyond.	
System Jitter		
TIME-DISTANCE Multiplier		
X.1	20 ps or less	
X1	0.2 ns or less	
X10	2 ns or less	



Fig. 1-1. 3S7/3T7 Time Domain Reflectometer.

ELECTRICAL CHARACTERISTICS (cont)

Characteristic	Performance Requirement	Supplemental Information		
Deflection Factor Accuracy (mV)	Within 3%			
VARIABLE UNITS/DIV Range	At least 2.5:1 (attenuation)	Continuously variable		
Input Signal Voltages				
Maximum Operating Voltage	+1 V to -1 V, of which the AC portion shall be no more than 0.6 VAC P-P.			
Safe Overload	±5 V DC			
Display Noise NORMAL RESOLUTION	1 mV or less (includes 90% of dots)			
DC OFFSET Range	+1 V, -1 V or greater			
VERT SIG OUT	200 mV/div within 5%			
VERT SIG OUT Source Resistance		10 kΩ within 2%		
TIME-DISTANCE Scale Accuracy	Within 1% of full scale when testing is done on TIME scale			
FINE (Zero Set)		Approximately 10% of TIME/DISTANCE range		
Distance Scales Calibration		The scales are based upon propagation velocity of light in free space (C) for air and 0.659 X C for polyethylene. C is 300 M/μs.		
PRESET Control Range		Adjusts the Poly scale to any dielectric propagation velocity of 0.659 X C to C.		
TIME/DIV Accuracy				
	TIME-DISTANCE MULTIPLIER			
	TOLERANCE	X10	X1	X.1
	±3%	1 μs 500 ns 200 ns	100 ns 50 ns 20 ns	10 ns 5 ns 2 ns
	+4.5%	100 ns 50 ns 20 ns	10 ns 5 ns 2 ns	1 ns 500 ps 200 ps
	±6%	10 ns 5 ns 2 ns	1 ns 500 ps 200 ps	100 ps
Variable TIME/DIV Range	At least 2.5:1 decrease in time/div	Continuously variable		

ELECTRICAL CHARACTERISTICS (cont)

Characteristic	Performance Requirement	Supplemental Information
SWEEP OUT		
Voltage	1 V/div within 5%	
Source Resistance		10 kΩ within 2%
SCAN MODE		
REPETITIVE Period (3S7 RESOLUTION NORMAL)	Adjustable with the SCAN control from 20 ms or less to at least 1 s	
MANUAL	Adjusted by SWEEP CAL for 10 div deflection	
EXT SCAN		
Deflection Factor	Variable from 1 V/div within 5% to at least 15 V/div.	
Input Resistance		100 kΩ within 20%
Maximum Safe DC Input		150 V
Sampling Rate Range		At least 10% period change as measured by Pulse Out Rate of 3T7

PHYSICAL CHARACTERISTICS

Characteristic	Performance Requirement	
Finish	Anodized aluminum front panel	
Weight	3S7	3T7
Net	2.75 lb	3.5 lb
Domestic Shipping	4.5 lb	5.25 lb
Export Packed	8.5 lb	9.25 lb
Dimensions	3S7	3T7
Length (overall)	14.499 in	14.549 in
Width	4.256 in	4.256 in
Height	6.256 in	6.256 in

ENVIRONMENTAL CHARACTERISTICS

Characteristic	Performance Requirement
Temperature	
Operating	0°C to +50°C
Non-operating	-40°C to +65°C
Altitude	
Operating	To 15,000 feet
Non-operating	To 50,000 feet

Accessories

Accessories supplied with the 3S7/3T7 Time Domain Reflectometer are listed in the Mechanical Parts List section.

NOTES

SECTION 2 OPERATING INSTRUCTIONS

Change information, if any, affecting this section will be found at the rear of this manual.

General Information

This section of the manual contains a description of the front panel controls, installation, mating, PRESET calibration, and a first time operation procedure.

The operator should be familiar with time domain reflectometry theory. Refer to the **Time Domain Reflectometry** circuit concepts book included as a standard accessory with the 3S7 TDR Sampler.

Front Panel Controls, Connectors, and Indicators

3S7 TDR Sampler

UNITS switch	The two position slide switch selects either $m\rho$ or mV as the unit-of-measure.
ρ CAL control	This screwdriver adjust control sets the gain of the vertical amplifier when measuring ρ .
POSITION lights	The trace position locator that indicates the vertical position of the trace relative to graticule center.
DC OFFSET (FINE) controls	The controls apply internal signal offset voltages to permit all portions of a signal within +1 V to -1 V to be positioned on the CRT for all UNITS/DIV switch positions.
UNCAL light	The light indicates that the UNITS/DIV VARIABLE control is not in the CAL position and that the UNITS/DIV are not as indicated.
GAIN control	The screwdriver adjust control sets the gain of the CRT Driver.
UNITS/DIV switch	The seven position switch selects the display units per division in a 1-2-5 sequence from 5 to 500. The actual units are either $m\rho$ or mV depending upon the UNITS switch position.

RESOLUTION switch	The switch, when in the HIGH position, helps to smooth a noisy display. The scan rate is reduced for HIGH resolution.
POLARITY switch	When this switch is in the +UP position, the display is normal (not inverted). When the switch is in the INVERT position, the display is inverted.
TEST LINE connector	The line under test is connected to this connector.
VERTICAL SIGNAL OUT jack	The jack provides a DC voltage reproduction of the displayed signal. The output amplitude is 0.2 V for each vertical division of display. The output impedance is 10 $k\Omega$.
PULSE IN connector	The signal from the 3T7 TDR Sweep PULSE OUT connector is applied to this connector via a 50 Ω coaxial line. It also serves as a signal input jack for synchroscope operation.

3T7 TDR Sweep

LOCATE push-button	The LOCATE pushbutton, when pressed, reduces the display magnification and shows the relative location of the time window by means of a brightened trace zone.
PRESET switch, light, control	A slide switch that selects between predetermined (TIME, AIR) scales or the POLY PRESET scale. When placed in PRESET as indicated by the light, the switch selects the polyethylene scale of the Time-Distance scales. In the PRESET position, the screwdriver adjust control permits recalibration of the POLY distance scale for dielectrics having a velocity of propagation between those of polyethylene and air.

TIME-DISTANCE control, scale The control is geared to the Time-Distance tape scale and permits time measurement to a discontinuity up to 10 μ s away from the Test Line connector. Two distance scales, one for air dielectric and one for polyethylene dielectric, permit distance measurement to a discontinuity up to 4920 feet, and 3240 feet, respectively.

FINE (ZERO SET) control This control permits the leading edge of the incident pulse to be positioned at the left-hand graticule edge when the TIME-DISTANCE scale is at zero.

TIME-DISTANCE switch The switch is concentric with the TIME/DIV switch. The TIME-DISTANCE scale reading must be multiplied by X10, X1, or X.1 (as indicated by the blue indicator on the knob's clear plastic skirt) to obtain the true measurement.

TIME/DIV switch This switch is concentric with the TIME-DISTANCE switch. It selects the time/div in a 1-2-5 sequence from 100 ps/div to 1 μ s/div (as indicated by the white dot on the MAGNIFIER knob). Display magnification up to 500X is obtained by pulling and rotating the MAGNIFIER knob clockwise.

TIME/DIV VARIABLE control The control is also concentric with the TIME/DIV control. Clockwise rotation of the knob decreases the time/div.

SWEEP CAL control The screwdriver adjust control sets the length of the CRT trace for proper horizontal calibration.

HORIZ POS control The screwdriver adjust control sets the CRT trace position horizontally.

SCAN MODE switch

- SINGLE SWP** This switch position provides display of a single sweep each time the START pushbutton is pressed.
- REPETITIVE** This switch position provides repetitive display.
- MANUAL** This switch position provides manual control of the scan, using the VARIABLE OR EXT ATTEN control.

EXT This switch position provides scan control by an external signal.

VARIABLE OR EXT ATTEN control This control sets the scan rate for all positions of the SCAN MODE switch and is a variable attenuator for EXT scan input signals.

PULSE OUT connector The GR connector provides pulses to the line under test. It is connected to the 3S7 Sampler PULSE IN connector by a 50 Ω coaxial cable.

SWEEP OUT jack The jack provides access to the sweep signal that is applied to the CRT Driver. The output is 1 V/div of horizontal deflection. It has a source impedance of 10 k Ω . The signal may be used to drive an X-Y recorder horizontal input.

START pushbutton The START pushbutton is used to start the sweep for the single sweep mode of operation.

IN jack The IN jack permits introduction of external scan control. A 0 V to 10 V ramp is required for a 10 division display.

SAMPLING RATE control The SAMPLING RATE screwdriver adjust control allows about 10% adjustment of the sampling rate. The control is used to eliminate false displays caused by RF interference.

Time Domain Reflectometer Installation

Be sure that the indicator oscilloscope Power switch is OFF before installing the 3S7 TDR Sampler and the 3T7 TDR Sweep. Install the 3S7 TDR Sampler in the Vertical (left) compartment and the 3T7 TDR Sweep in the Horizontal (right) compartment. Each plug-in has a lock knob which should be turned clockwise to firmly seat and lock the plug-in in place.

Install the supplied standard accessory coaxial cable (10 inch length for the standard oscilloscope and 20 inch length for the rack mount oscilloscope) between the 3T7 TDR Sweep PULSE OUT connector and the 3S7 TDR Sampler PULSE IN connector. The Time Domain Reflectometer should have been mated previously to the oscilloscope before installing the cable. See the mating procedure which follows.

Mating the Time Domain Reflectometer to the Oscilloscope

The Time Domain Reflectometer must be mated to the oscilloscope when it is first installed. The completion of the following steps provide a calibrated system.

1. Adjust Vertical GAIN Control

a. Set the Sampler controls as follows:

UNITS	mV
UNITS/DIV	100
VARIABLE	CAL
DC OFFSET	mid-position
RESOLUTION	NORMAL
POLARITY	+UP

b. Set the Sweep controls as follows:

TIME/DIV	200 ns
TIME-DISTANCE	0
PRESET	Right position
SCAN MODE	REPETITIVE
VARIABLE OR EXT ATTEN	fully clockwise

c. Connect the supplied 50 Ω GR termination to the Sampler TEST LINE connector.

d. Connect a 50 Ω BNC coaxial cable and a GR to BNC female adapter from the Sampler PULSE IN connector to the oscilloscope Cal Out connector. A patch cord, such as a test lead, may be used.

e. Select a Calibrator signal (into 50 Ω) amplitude in the 100 mV to 500 mV range only and a UNITS/DIV amplitude in the Sampler to obtain at least two vertical divisions of display.

f. Adjust the Sampler front panel GAIN control (screwdriver adjust) to obtain the correct displayed amplitude.

g. Remove the coaxial cable and the adapter.

2. Adjust SWEEP CAL and HORIZ POS Controls

a. Place the SCAN MODE switch to MANUAL.

b. Rotate the VARIABLE OR EXT ATTEN control throughout its range and adjust the SWEEP CAL control (screwdriver adjust), if necessary, so that the dot range of

movement is from graticule line zero to graticule line ten. The HORIZ POS control may be adjusted as necessary to accomplish this step.

c. Place the SCAN MODE switch at REPETITIVE.

d. Install the supplied 10 inch or 20 inch coaxial cable between the Sweep PULSE OUT connector and the Sampler PULSE IN connector to complete the mating.

FIRST TIME OPERATION

Introduction

The purpose of this procedure is to familiarize the operator with the operation of the Time Domain Reflectometer. The procedure shows methods of measuring the round-trip time to a discontinuity, the one-way distance to the discontinuity, and the voltage reflection coefficient at the discontinuity.

The book, **Time Domain Reflectometry Measurements**, supplied with the 3S7 discusses the theory and application of the Time Domain Reflectometer.

Measurement Procedure

1. Install a line to be tested on the Sampler TEST LINE connector. The 20 cm air line is used in this illustration.

2. Set the Sampler controls as follows:

UNITS	mV
UNITS/DIV	500
VARIABLE	CAL
DC OFFSET	mid-position
RESOLUTION	NORMAL
POLARITY	+UP

3. Set the Sweep controls as follows:

TIME/DIV	500 ps
TIME-DISTANCE	0
FINE (ZERO SET)	fully clockwise
PRESET	Right position
SCAN MODE	REPETITIVE
VARIABLE OR EXT ATTEN	fully clockwise

4. Produce an inductive discontinuity at the TEST LINE connector by partially disengaging the air line connector from the TEST LINE connector. Adjust the FINE control to position the discontinuity (see Fig. 2-1) at graticule line 1 (reference), then fully engage the connector.

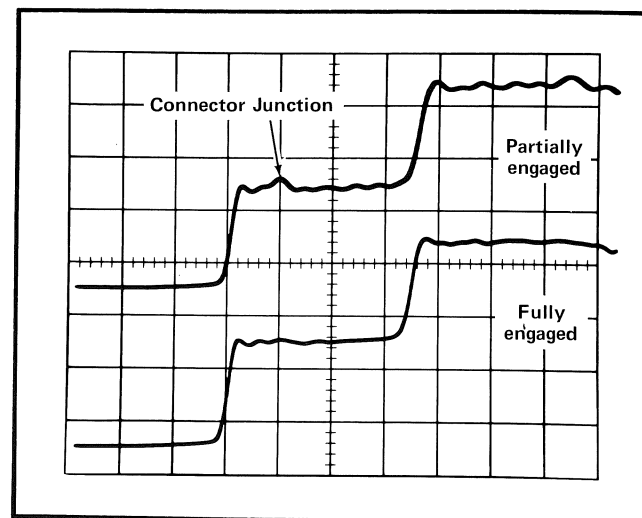

Fig. 2-1. TEST LINE connector junction location obtained by partially engaging the line to the connector.

5. Measure the round-trip time from graticule line 1 to the discontinuity directly on the CRT display. With a 20 cm Air Line attached, the round-trip time should be 2.6 major divisions times 500 ps (approximately 1.3 ns). Ignore the X.1 TIME-DISTANCE multiplier setting while making this measurement.

6. Move the discontinuity to the reference line by turning the TIME-DISTANCE control (crank handle in the knob). The TIME scale reading on the TIME-DISTANCE readout is then multiplied by the X.1 which is indicated by the TIME-DISTANCE multiplier switch indicator to obtain the correct time. (Ignore the TIME/DIV setting.) The round-trip time is 1.3 ns.

7. Read the distance to the discontinuity on the AIR scale and multiply the reading by X.1, which is indicated by the TIME-DISTANCE switch indicator. (Again, ignore the TIME/DIV setting.) The distance to the discontinuity is 0.65 feet.

8. Measure the voltage reflection coefficient ($m\rho$), due to the reflected signal from the top of the pulse to the top of the discontinuity. The voltage reflection coefficient ($m\rho$) is +1000, which is a ρ of +1.

FRONT PANEL ADJUSTMENTS

Rho CAL Adjustment

1. Connect the 10 inch coaxial cable (or 20 inch coaxial cable if a rack mount oscilloscope is used) from the Sweep PULSE OUT connector to the Sampler PULSE IN connector.

2. Terminate the TEST LINE connector with a 50 Ω termination.

3. Place the UNITS switch to $m\rho$.

4. Place the UNITS/DIV switch to 200.

5. Adjust the ρ CAL control (screwdriver adjust) for a five division displayed step amplitude.

PRESET Calibration

The Poly scale must be recalibrated for cables having a velocity of propagation greater than that of polyethylene, which is 0.659 times the speed of light in free space.

The following procedure recalibrates the Poly scale when the PRESET switch is at the left position.

1. Place the PRESET switch at the left position.

2. Place the UNITS/DIV switch to 500.

3. Install a KNOWN length of the type of unterminated cable that is to be measured on the TEST LINE connector.

4. Place the TIME-DISTANCE scale at zero.

5. Produce an inductive discontinuity at the TEST LINE connector by partially disengaging the air line connector from the TEST LINE connector. Adjust the FINE control to position the discontinuity (a bump on the displayed waveform) at a convenient reference line and then fully engage the connector. See Fig. 2-1 which illustrates this discontinuity.

6. Place the TIME-DISTANCE scale at the KNOWN length readout of the POLY-PRESET scale.

7. Adjust the PRESET calibration control, at the left of the PRESET indicator light, so that the reflected pulse is positioned at the reference graticule line.

SAMPLING RATE Adjustment

False displays due to radio frequency interference may be eliminated by adjusting this control and placing the 3S7 RESOLUTION switch at HIGH. Distortion of external

input signals to the Sampler may be reduced by the adjustment of this control.

OPERATION INFORMATION

TIME-DISTANCE Scales

The TIME scale indicates the round-trip time between the test (incident) pulse that is applied to the line and the reflected pulse from the discontinuity in the line.

The AIR scale indicates the one-way distance to the discontinuity in an air-line (rigid coaxial line having an air dielectric).

The POLY/PRESET scale indicates the one-way distance to the discontinuity in a coaxial cable that has POLY-ethylene dielectric or other dielectric which has a velocity of propagation greater than polyethylene. The scale is calibrated for polyethylene when the PRESET switch is placed at the right position, and for other dielectric when the PRESET switch is placed at the left position. The PRESET scale must be calibrated to the particular dielectric that is used in the line. The PRESET scale calibration procedure is given in this Operating Section. Note that polyethylene cables having braided outer conductors typically have propagation velocities greater than that of an ideal polyethylene cable.

All time and distance readings on the TIME-DISTANCE scales must be multiplied by the X10, X1, or X.1 indicated by the TIME-DISTANCE switch (blue indicator, concentric with the TIME/DIV switch) to obtain the correct time or distance.

TIME-DISTANCE Multiplier and MAGNIFIER Operation

The time window that the CRT displays is equal to the TIME/DIV switch setting times the ten divisions of the graticule. This time window may be shifted by the TIME-DISTANCE control from 0 to 1 μ s times the TIME-DISTANCE multiplier (X10, X1, or X.1) for a maximum of 10, 1, or 0.1 μ s. The total length of line that may be viewed (in terms of round trip time) is the sum of the viewed time window and the TIME-DISTANCE readout. For an example of this, place the TIME-DISTANCE multiplier (blue indicator) in the X10 range and pull and rotate the MAGNIFIER knob, to place the white dot indicator at 20 ns. The CRT time window is 10 div X 20 ns/div or 200 ns. This time window may be shifted a maximum of 10 μ s (TIME-DIVISION multiplier of 10 times 1 μ s of the TIME-DISTANCE readout). This gives a total time viewing range of 10.2 μ s which corresponds to a 3305-foot coaxial cable having polyethylene dielectric. From Table 2-1 (Page 2-7),

the magnification at 20 ns/div is X50 (fifty times that of the 1 μ s/div reference).

The selection of the TIME-DISTANCE multiplier and the MAGNIFIER switch position depends upon the length of line and the resolution required. Magnifications of X200 or X500 may display jitter; therefore, for short lines a lower value TIME-DISTANCE multiplier should be selected when possible.

Magnification of the display occurs at graticule line zero. This may be observed by placing the TIME/DIV switch a 1 μ s and the test pulse at 0.5 div from the graticule zero line. Turn the TIME/DIV switch to observe the shift of the pulse edge to the right.

Time and Distance Measurement Procedure

1. Connect the line to be tested to the Sampler TEST LINE connector (an adapter may be required).

2. Set the Sampler UNITS/DIV switch.

3. Set the Sweep TIME/DIV switch.

4. Set the TIME-DISTANCE scale at zero.

5. Produce an inductive discontinuity at the TEST LINE connector by partially disengaging the air line connector from the TEST LINE connector. Adjust the FINE control to position the discontinuity (a bump) at a convenient reference line and then fully engage the connector (see Fig. 2-1).

6. Position the discontinuity at the reference graticule line by using the TIME-DISTANCE control (crank in knob).

7. Multiply the TIME-DISTANCE reading by the X10, X1, or X.1 that is indicated by the TIME-DISTANCE switch indicator (blue indicator on the clear plastic skirt). This obtains the round-trip time or the one-way distance to the discontinuity.

Coupling Capacitor Usage

Coupling capacitors having values greater than 0.02 μ F should not be inserted between the TEST LINE connector and the line to be measured. This capacitance limitation is necessary to ensure proper operation of the Pulser in the Sweep.

Air Line Usage

Small discontinuities at the beginning of the line under test are sometimes more easily located by inserting the air line between the Sampler TEST LINE connector and the line under test. The high quality air line moves (delays) the first expected discontinuity about 1.4 ns from the incident pulse edge and into an area of smaller system discontinuities.

Long Transmission Line Measurement

Long transmission lines should be terminated at the far end when they are to be measured with the Time Domain Reflectometer. A transmission line may be considered to be long if its total shunt capacitance exceeds 0.02 μF . This value of capacitance is obtained in about 660 feet of polyethylene coaxial cable, or 1000 feet of air dielectric transmission line. Incorrect measurement and/or damage to the Pulser in the Sweep may result if the line is unterminated.

Voltage Reflection Coefficient (Rho) Measurement

The book, *Time Domain Reflectometry Measurements*, which is provided as a standard accessory, gives a complete discussion of the theory and measurement of the voltage reflection coefficient (ρ). This discussion is concerned with the operation of the Time Domain Reflectometer in performing the measurement.

The voltage reflection coefficient is obtained directly by measuring the amplitude of the reflected pulse. The top of the incident pulse is the zero reference line from which the measurement of the reflected pulse is taken. The base (or start) of the incident pulse is ignored when making a measurement. A positive reflected pulse (above the zero reference line) is obtained when the discontinuity impedance is greater than the characteristic impedance of the line. A negative reflected pulse (below the zero reference line) is obtained when the discontinuity impedance is less than the characteristic impedance of the line. Direct read-out of millirho is possible, since the E_{incident} is 1000 in the definition of ρ ($\rho = E_{\text{reflected}}/E_{\text{incident}}$).

Rho is also expressed as: $\rho = (R_l - Z_0)/(R_l + Z_0)$, where R_l is the load resistance and Z_0 is the characteristic impedance of the transmission line. R_l may be computed from the derived expression: $R_l = Z_0 (1 + \rho)/(1 - \rho)$.

Fig. 2-2 shows a voltage reflection coefficient (in terms of millirho) of -500 (or a rho of -0.5). This is the result of terminating the transmission line (a 20-cm air line) with a resistance of about 17 Ω . Fig. 2-3 shows a voltage reflection coefficient (in terms of millirho) of +500 (or a rho of +0.5). This is the result of terminating the transmission line with a resistance of about 150 Ω . Lossless transmission line con-

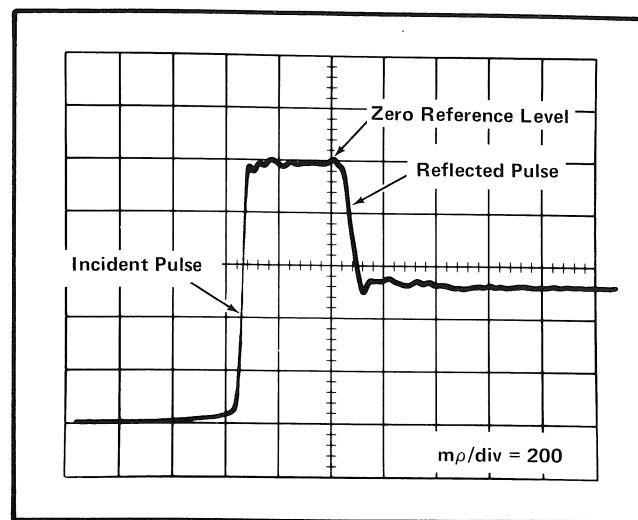

Fig. 2-2. Voltage Reflection Coefficient measurement illustration. The transmission line is terminated with a resistance which is less than its characteristic impedance.

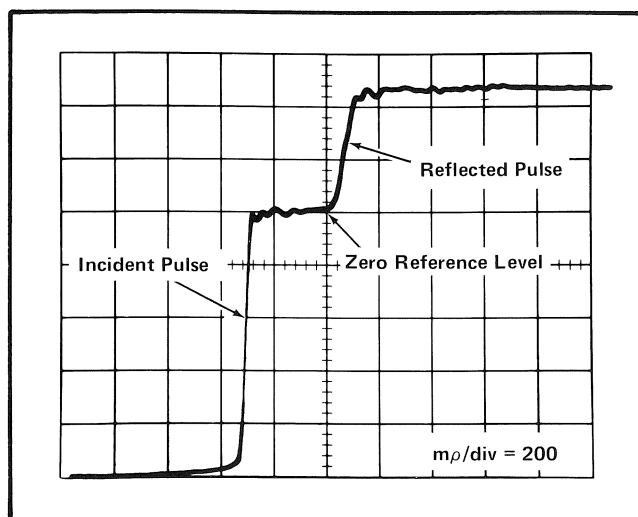

Fig. 2-3. Voltage Reflection Coefficient measurement illustration. The transmission line is terminated with a resistance which is greater than its characteristic impedance.

ditions are assumed for these examples. Modifications to the voltage reflection coefficient measurement must be taken into account when significant amounts of line loss are encountered.

Synchroscope Applications

The Time Domain Reflectometer may be used to measure the transfer coefficient of passive and active networks. This is accomplished by driving the network input with the Sweep test pulse, applying the network output signal to the Sampler PULSE IN connector and observing

the display. Input and output impedance matching networks, which reduce signal distortion, may have to be connected to the circuit under test. Fig. 2-4 shows the equipment interconnections for performing the measurement.

The input impedance matching network is not required if the circuit under test has a 50 Ω input impedance. Passive

circuits having greater than 50 Ω impedance require an impedance matching network. Input and output impedance of about 5 k Ω is the maximum that can be used in a passive circuit and still retain good resolution of the signal. An active circuit may have higher input impedance if it has sufficient gain. The impedance matching network for the output of a circuit may be a Tektronix P6034 or P6035 Probe.

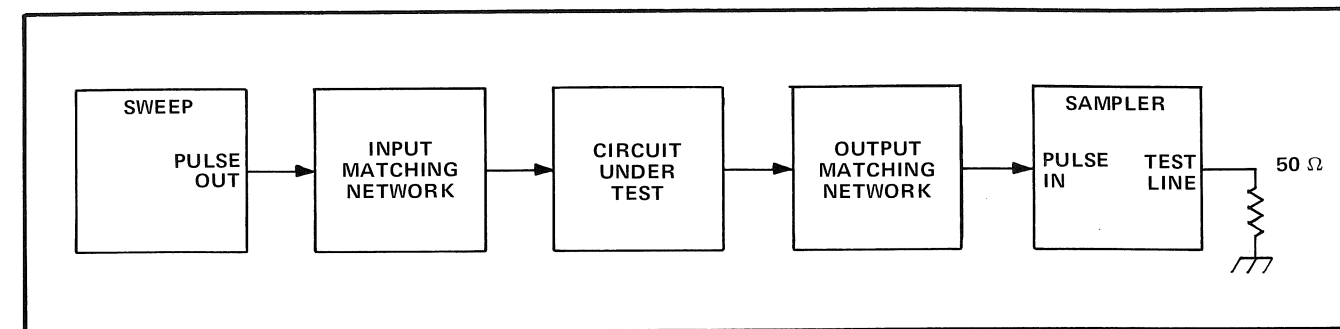

Fig. 2-4. Equipment set-up for measuring an active or passive circuit transfer coefficient.

TABLE 2-1

		TIME WINDOW MAGNIFICATION								
		BASIC RANGE			MAGNIFIER (pull to unlock)					
		X1 REF.	X2	X5	X10	X20	X50	X100	X200	X500
TIME-DISTANCE MULTIPLIER	X10	1 μs	500 ns	200 ns	100 ns	50 ns	20 ns	10 ns	5 ns	2 ns
	X1	100 ns	50 ns	20 ns	10 ns	5 ns	2 ns	1 ns	500 ps	200 ps
	X.1	10 ns	5 ns	2 ns	1 ns	500 ps	200 ps	100 ps		

NOTES

SECTION 3 CIRCUIT DESCRIPTION

Change information, if any, affecting this section will be found at the rear of this manual.

Introduction

This section contains a discussion of Time Domain Reflectometry, a block description of the TDR system, and a detailed description of the circuitry in each block.

TIME DOMAIN REFLECTOMETRY

Time Domain Reflectometry is a method of locating and measuring transmission line discontinuities. A discontinuity is a change in the characteristic impedance of a line, due to a difference in a physical or electrical parameter of a line. For instance, the diameter of the inner conductor may differ at one point as compared to another in a coaxial line. This difference causes the resistance, capacitance or inductance to vary at that point, thus changing the characteristic at that point.

If a step function is applied to one end of a transmission line, the wavefront caused by that step travels to the end of the line and is reflected back to the source. The reflection amplitude is directly proportional to the amount of irregularity of line impedance.

If an oscilloscope is connected to the line at the point of step application, both the incident (applied) step and any reflections can be viewed on the CRT display. However, the step risetime must be extremely short in order that high-frequency characteristics can be measured. A sampling oscilloscope system is necessary to display such a short risetime.

The 3S7, 3T7, and indicator oscilloscope comprise a TDR system which generates fast pulses to be applied to a transmission line, and displays the incident and reflected pulses (see Fig. 3-1). Physically, the system is composed of the 3T7 Sweep, which generates the test pulse for the transmission line and furnishes the time base for the horizontal display; the 3S7 Sampler, which processes the incident pulse and any reflections from the test line, to be displayed on the indicator oscilloscope; and the indicator oscilloscope, which displays the incident pulse and its reflections.

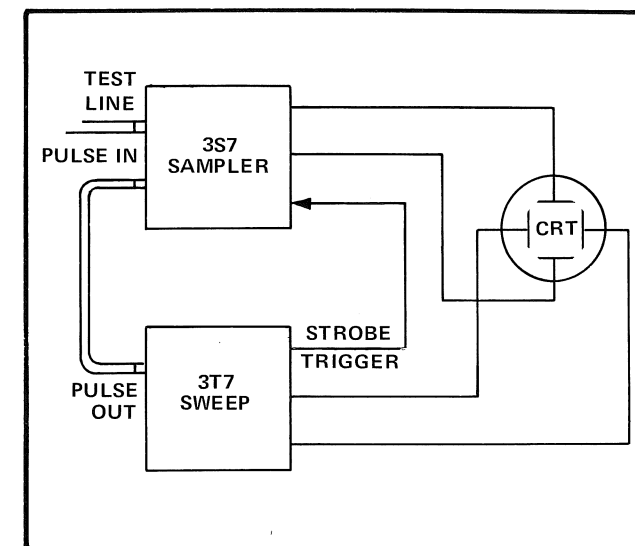

Fig. 3-1. Simplified Sampler-Sweep interconnection.

BLOCK DESCRIPTION

Fig. 3-2 is a functional block diagram of the TDR system. It is composed of five basic blocks:

The Scan circuits generate the time base for the horizontal display. They also provide a time-reference for generating the strobe signal.

The Timing circuits generate a trigger for use by the sampler (strobe signal) and the pulser circuits.

The Pulser circuits generate the pulse (incident pulse) applied to the test line. A portion of this pulse is sent to the Sampler.

The Sampler circuits, as controlled by the incoming strobe trigger, take samples of the signal on the test line, process them, and send them to the CRT for display.

The CRT displays the X and Y axis inputs as a composite representation of the actual signal at the Sampler input.

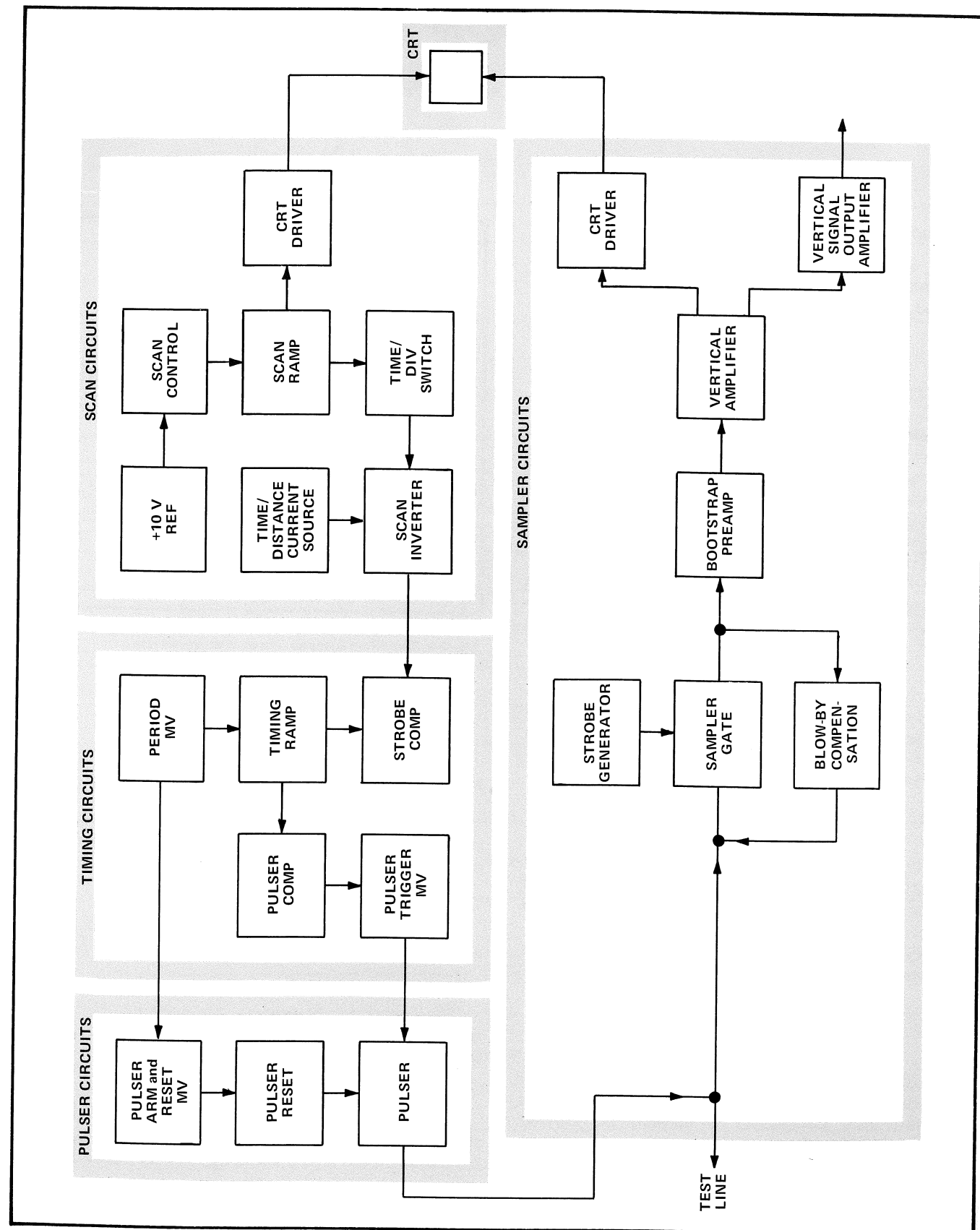

Fig. 3-2. TDR System block diagram.

System Function

Generally, the system functions as follows: The scan circuits generate a ramp for display on the CRT. The ramp is also sent to the Strobe Comparator, where it is compared against the timing ramp from the timing circuits. This comparison determines the point at which a sample of the signal is to be taken. With each timing ramp, the sample is taken progressively further along the display ramp.

The timing ramp is used also to trigger the pulser circuits. The output of the Strobe Comparator is sent to the Sampler circuits, where it is used to initiate each sample.

The pulser sends pulses out the test line and into the Sampler. The Sampler takes one sample of a point on each pulse, each sample being taken at a point slightly later along the pulse. Since the Sampler input is directly connected to both the pulser output and the test line, the Sampler output to the CRT is a combination of the incident pulse and test-line reflections.

DETAILED DESCRIPTION

Refer to the diagrams at the rear of this manual.

Sampler Circuits ① ②

Strobe Generator. At the time the 3S7 is to take a signal sample, it receives a strobe trigger from the 3T7 Strobe Comparator (see Fig. 3-3). For each trigger received, the Strobe Generator develops two fast-rise, short-duration, pulses of opposite polarities to drive the Sampler Gate into balanced conduction.

The incoming Strobe pulse is used to drive multivibrator Q65, Q70, and surrounding components. Before the pulse

arrives, both transistors are off. When the pulse arrives, both transistors are rapidly turned on, generating a fast-rise pulse which is coupled via T70 to the base of Q75, an avalanche transistor. When the Strobe pulse ends, the multivibrator switches back to quiescence.

The positive drive pulse from T70 turns on Q75, which produces a push-pull output to the snap-off diode circuit. R78, the avalanche adjustment, sets the collector-to-emitter voltage of Q75. This adjustment ensures that the snap-off diode receives the proper signal amplitude.

The Snap-off circuit operates as a current-switching circuit to apply some of the push-pull avalanche current to the Sampling Bridge at snap-off time. The circuit consists of snap-off current control R81, Q85, and R85; snap-off diode CR86; two clipping lines; and other associated components. Between drive pulses from the Avalanche circuit, CR86 is forward-biased by the current through Q85. This current is set by R81, and is typically 8 mA. This current assures that CR86 has many carriers in its junction region.

The push-pull signals from Q75 cause the CR86 junction carriers to reverse direction as a heavy reverse current. This heavy reverse current stops suddenly as the carriers clear out of the junction. As the reverse current "snaps" to a stop, the push-pull signals are coupled toward the clipping lines and Sampling Bridge. A step is propagated down each line, and reflected back in reverse polarity, to cancel the signals moving toward the Sampling Bridge. This results in a positive strobe pulse being delivered to CR6 and a negative strobe pulse being delivered to CR12, which biases both diodes into conduction.

Sampling Gate. The Sampling Gate consists of CR6, CR12, C8, C14, R6, R8, R12, and R14. These components

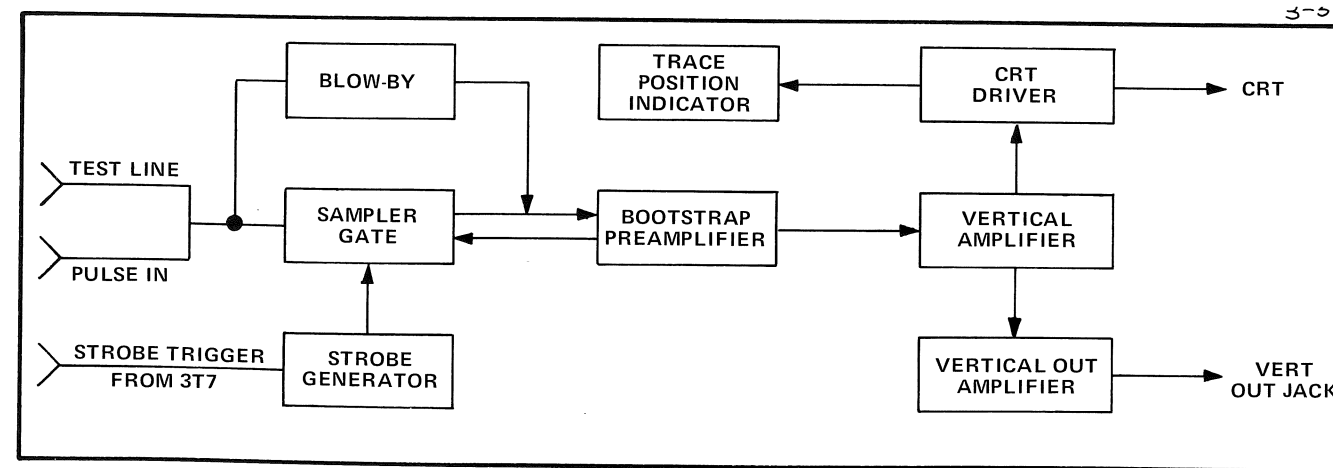

Fig. 3-3. 3S7 TDR Sampler circuit block diagram.

form a bridge network. The gate diodes are shut off except when strobed by the Strobe Generator, at which time the input signal is passed through the diodes to the Memory Capacitor.

The Memory Capacitor is composed of C6, C12, C92, C94, and shunt capacitance to ground. The capacitors are charged and discharged by the input signal and the Bootstrap Amplifier output signal (fed back through C9 and C15).

Blow-by Circuit. The Blow-by circuit corrects for the unwanted, capacitively-coupled signals that bypass the Sampling Gate diodes. Q5 amplifies and inverts part of the input signal, and couples it through C5 to the Sampling Gate output to eliminate the effects of the blow-by signal.

Bootstrap Preamplifier. The Bootstrap Preamplifier is an operational amplifier composed of differential amplifier Q20, constant current source Q25, and inverter Q35. It is connected as an in-phase amplifier which has a DC gain of two.

The signal from the Sampling Gate is applied to the gate of Q20A, whose drain output drives Q35. The signal output of the amplifier is taken from the junction of R27 and R36, applied to the following stage (U50A), and coupled back to the Sampling Gate. C18 controls the amount of signal that is fed back to the input.

The effect of the feedback signal is to reduce the effective capacitance to ground of the Sampling Gate, by charging the Sampling Gate output capacitance with an in-phase signal.

The trace OFFSET controls (R30 and R31) set the bias of Q20B gate, which is the $-$ input of the operational amplifier. This signal, and the memory capacitor voltage, set the DC output level of the amplifier.

Vertical Amplifier. The Vertical Amplifier is composed of three cascaded operational amplifiers which are contained in a single integrated package (U50).

The signal from the Bootstrap Preamplifier is applied to the negative input of the first operational amplifier U50A through the UNITS/DIV switch, which selects the input resistance (and thereby the gain) of the operational amplifier. The range of voltage gain is 0.1 to 10, referred to the Preamplifier output. The switch connects all input resistors in parallel to ground except the resistor in use, thus the

Bootstrap Preamplifier drives a $1\text{ k}\Omega$ load regardless of the switch position. Diodes CR48 and CR49 limit the maximum peak-to-peak voltage excursion of the $-$ input to the amplifier to prevent overload under conditions of high gain and large driving signal amplitude.

The second amplifier stage (U50B) has a positive voltage gain of 4 when the UNITS switch is in the μp position, and a voltage gain of 1 when it is in the mV position. The RESOLUTION switch in the HIGH position connects capacitor C120 into the circuit to smooth the resolution of the display.

With R40 (Units/Div VARIABLE) in the CAL position, the voltage gain of the third-stage amplifier U50C is approximately 10, with a negative-polarity output signal. The VARIABLE control is part of the input resistance. This control permits uncalibrated settings of the UNIT/DIV switch. Diodes CR130 and CR132 limit the maximum P-P drive signals. The output of this stage is applied to the CRT Driver and to the Vertical Signal Out Amplifier.

CRT Driver. The CRT Driver is composed of differential amplifier Q145 and Q165. The POLARITY switch inverts the display by interchanging the input signals to the differential amplifier. GAIN control R172 (front panel screw-driver adjust) sets the gain of this stage.

Trace Position Indicator

The Trace Position Indicator lights indicate the trace position relative to the graticule center. It is composed of indicator light drivers Q155 and Q175. The transistors are differentially connected, and are driven by the emitter signals of the CRT Driver.

Vertical Signal Out Amplifier. The Vertical Signal Out Amplifier provides a front panel signal output of 0.2 V/div of display signal. This operational amplifier is also contained in the integrated circuit.

TDR SWEEP

This description covers the 3T7 circuits and their operation in each block (see Fig. 3-4). Each block is discussed in a signal sequence whenever possible. The description for the Repetitive Mode of operation is arranged in the following order: scan, scan reset, automatic Pulser bias adjust, and locate operation.

Scan Operation

During Scan Operation, the trace moves across the CRT while the sampled signal information is being displayed.

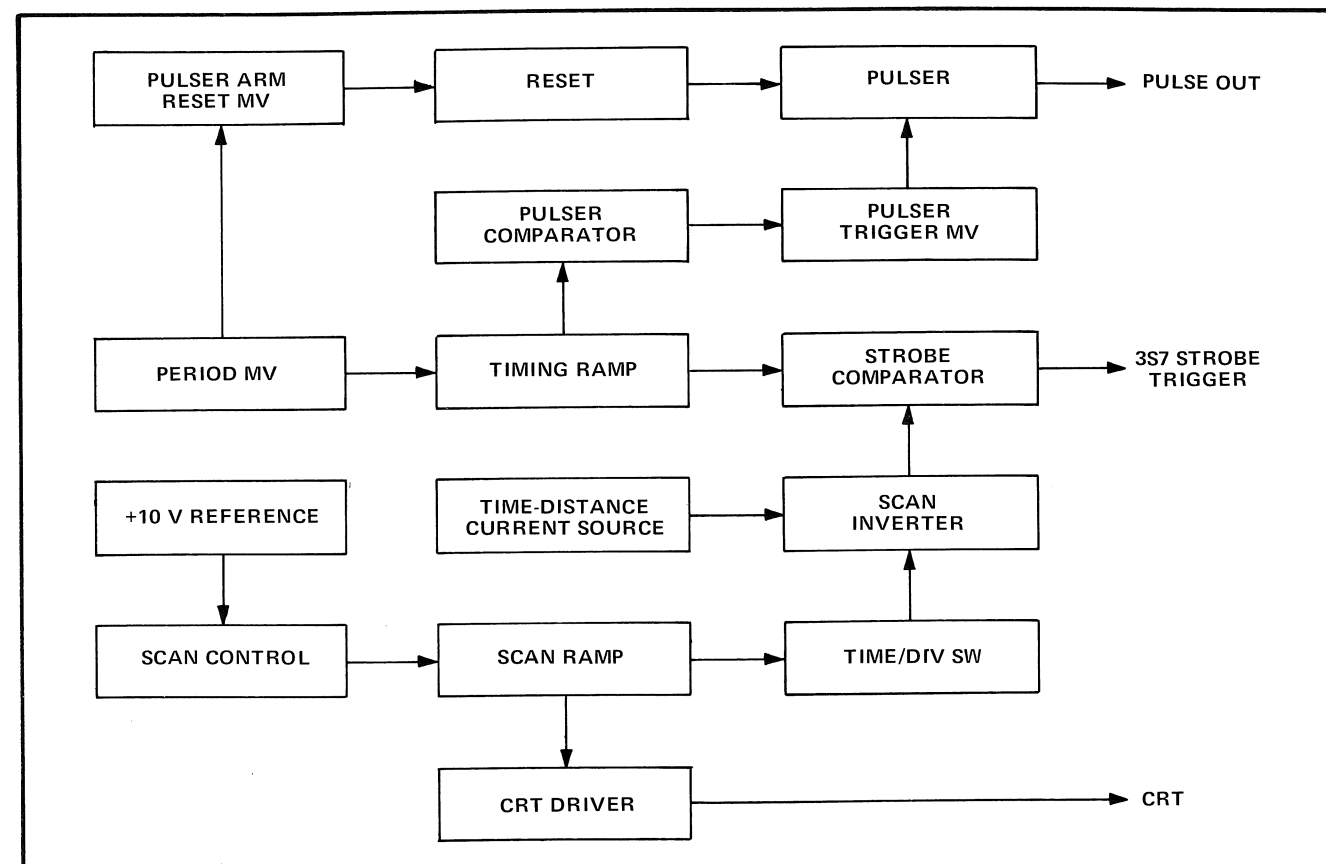

Fig. 3-4. 3S7 TDR Sweep Scan circuit block diagram.

Period Multivibrator. The Period Multivibrator sets the system sampling rate. Its frequency is approximately 25 kHz, set by the front panel Sampling Rate control (screw-driver adjust) and by R412 on the circuit board. The Period Multivibrator is composed of operational amplifier U395D, which generates a square wave, and switch Q405, which turns off the multivibrator during scan reset time.

The Period Multivibrator square wave output switches between $+12.5\text{ V}$ and -0.5 V . Positive feedback resistor R410 and voltage divider R406-R408 set the U395D $+$ input voltage. Signal voltage is a square wave of $+0.5\text{ V}$ to -0.5 V . Negative feedback resistors R411, R412, and R413 with C413 set the Period Multivibrator frequency. The signal at the $-$ input is a triangular waveform that varies from $+0.5\text{ V}$ to -0.5 V . The Period Multivibrator output signal and the $-$ input signal are applied to the Pulser Arm-Reset Multivibrator $+$ input and $-$ input, respectively. The Period Multivibrator output signal is also applied to the Timing Ramp generator. When Q405 is turned on during the scan reset, U395D $+$ input is held at -2 V , which is lower than the $-$ input voltage range, and the Period Multivibrator is held in its low output state.

One cycle of the Period Multivibrator operation is as follows: The Period Multivibrator output switches from $+12.5\text{ V}$ to -0.5 V and C413 discharges from $+0.5\text{ V}$. When the $-$ input voltage becomes less than the $+$ input voltage (-0.5 V), the Period Multivibrator output goes from -0.5 V to $+12.5\text{ V}$ and C413 charges. When the $-$ input voltage becomes greater than the $+$ input voltage ($+0.5\text{ V}$), the Period Multivibrator output goes back to -0.5 V .

Timing Ramp. The Timing Ramp is driven by the Period Multivibrator and generates a negative voltage ramp which is applied to the Pulse Comparator and to the Strobe Comparator. The ramp slope is selected by the Time-Distance Multiplier switch X10, X1, and X.1 positions. The Timing Ramp circuitry includes Q520, Q525, and Q530.

Q520 is a grounded base driver for Q525. Q530 provides the constant charging current for the timing capacitors (C525, C526, C527, and C528). Q525 clamps the timing capacitor voltage at -0.7 V between ramps. The X10, X1, and X.1 timing ramp rates are 0.5, 5, and $50\text{ V}/\mu\text{s}$ respectively and are about 12 V in amplitude.

Pulse Comparator. The Pulse Comparator compares the Timing Ramp voltage with a fixed voltage to provide a trigger signal to the Pulser Trigger Multivibrator. The Pulse comparator is composed of Q540-Q545.

The Timing Ramp voltage is applied to Q540 base and the reference voltage is applied to Q545 base. When the ramp voltage becomes less than the comparison reference voltage, Q540 turns off and Q545 turns on and provides a negative drive signal to the Pulser Trigger Multivibrator. R546, R547, and R548 set the timing of the pulse waveform for each of the Timing Ramp slopes.

Pulser Trigger Multivibrator. The Pulser Trigger Multivibrator generates the drive signal for the Pulser when actuated by the Pulse Comparator. The Pulser Trigger Multivibrator is composed of driver Q560 and monostable multivibrator Q562-Q575.

A negative pulse from the Pulse Comparator drives Q560, which turns on Q562. The negative collector signal of Q562 turns on Q575. The positive Q575 collector signal triggers the Pulser and also drives Q562 base to provide positive (regenerative) feedback for a fast trigger pulse rise-time.

Pulser. The Pulser generates the fast-rise positive output step that is applied to the coaxial system under test. Tunnel diode CR587 is the active element in the Pulser. It is triggered at the rate set by the Period Multivibrator.

The tunnel diode is armed through Q585 by a current which is the sum of the currents from R455, R457, and R442 (Pulser Memory, Q440 output). The tunnel diode triggers (switches to its high level) when it receives the Pulser Trigger Multivibrator trigger current through C587. The tunnel diode remains in its high state until reset by removal of the current from Q585. After the tunnel diode is reset, it is then armed by the Pulser Arm-Reset Multivibrator.

Pulser Arm-Reset Multivibrator. The Pulser Arm-Reset Multivibrator (operational amplifier U395C) is controlled by the Period Multivibrator and develops a pulse to turn on the Reset circuit.

When the Period Multivibrator switches to its low state, a negative pulse is applied to the Pulser Arm-Reset Multivibrator +input to switch its output to -0.5 V. The Pulser Arm-Reset Multivibrator output remains negative until the drive to its $-$ input from C413 goes from $+0.5$ V to 0 V. The Pulser Arm-Reset Multivibrator then switches to its high state at a time midway between the Pulser reset and

the next trigger pulse arrival. When the Pulser Arm-Reset Multivibrator is in its low state, its negative output is applied to U270A base, which turns on the Reset.

Reset. The Reset circuit (U270A and B) removes the current from Pulser tunnel diode CR587.

The Pulser Arm-Reset Multivibrator develops a negative pulse that switches off U270A, turning on U270B and diverting the current going to the Pulser. The tunnel diode in the Pulser switches to its low state when its arming current is removed.

+10 V Reference

Operational amplifier U395B and constant current source Q398 form a +10 V reference that, by way of the Scan control, is used in the Single Sweep, Repetitive, and Manual modes of operation. The value of the voltage reference is determined by the actual value of the -12.2 V and the -100 V supplies in the mainframe. These supplies are also used to set the currents for the Timing Ramp and the Time-Distance control.

When the 3T7 calibration is checked upon insertion into a new indicator frame, the +10 V Reference supply is used to check for a 10-division range of movement of the dot that appears when the Manual Scan mode of operation is used. Since the absolute voltage level of this supply is proportional to the Timing Ramp current, variations in the -12.2 V or the -100 V supplies are compensated and do not cause timing errors.

Scan Control. The Scan Control (operational amplifier U210C) functions as an inverter for the Single Sweep and Repetitive modes of operation. Its output at pin 9 varies from +10 V to 0 V when the Scan Mode VARIABLE control is rotated clockwise from the fully counterclockwise position. The output voltage drives the $-$ input of the Scan Ramp.

In the Manual and External Scan modes of operation, the Scan Control functions as a voltage follower, and is used to directly drive the Timing Switch Attenuators and the CRT Driver.

Scan Ramp. The Scan Ramp circuitry includes the Scan Ramp generator (operational amplifier U210D) and ramp reset switch (Q200). The Scan Ramp generates the 0 V to +10 V ramp that is applied to the Timing Switch attenuators and to the CRT Driver for the SINGLE SWEEP and REPETITIVE modes of operation. The signal is also applied to the Scan Ramp Reset Multivibrator for all modes of operation.

The Scan Ramp generator is a Miller integrator which has C200 (and C202 in High Resolution mode) as the feedback capacitor. The output moves positive as the $-$ input receives current from the -100 V source via R207 and R206. The current supplied to the $-$ input is the algebraic sum of the current through R207 and the current through R208 from the Scan Control output (0 V to +10 V).

With the VARIABLE Scan control fully counterclockwise, the positive current from R208 is at a maximum, cancelling the negative current from R207. R206 is adjusted for a minimum of one scan ramp per second. In the fully clockwise position, the VARIABLE Scan control will give about 50 scan ramps per second.

High resolution of the display is obtained by switching C202 in parallel with C200. This decreases the scan repetition rate by a factor of 23, which results in 23 times as many samples per scan. The RESOLUTION switch is on the 3S7 front panel.

The Scan Ramp is reset to 0 V when Q200 receives a positive pulse during the Scan Ramp reset operation. Q200 is turned on by the positive pulse and discharges the feedback capacitor.

Time/Div Switch. The Time/Div switch selects the input resistors that set the Scan Inverter gain. The switch positions are in a 1-2-5 sequence to obtain Time/Div scale factors of 100 ps/div to 1 μ s/div.

Time-Distance Current Source. This circuit supplies current to the Scan Inverter, and to the Locate circuit when the Locate button is pushed. It is composed of constant current source Q290, which drives Q293 (and related components). Q290 along with the +10 V Reference and the Timing Ramp, uses the -12.2 V and the -100 V voltage sources to establish a compensated constant current reference. Q293 collector output drives Q295, which is a current source for front panel Time-Distance control R295. R295 is a current divider, so that only a portion of the current to R295 goes to the $-$ input of the Scan Inverter. The current from R295 is an analog of the time or distance measurement. The front panel Fine (Zero Set) control is used to set the zero reference position of the displayed waveform when performing a measurement. It can also be used for fine adjustment of the Time Position when large magnifications are used (5 ns/div with X10 Multiplier).

Scan Inverter

The Scan Inverter (U210A and Q340) inverts the signal from the Scan Ramp which is attenuated by the Time/Div switch. The output signal drives the Strobe Comparator and the Locate circuit.

The signal to the $-$ input of operational amplifier U210A-Q340 is the sum of the Scan Ramp signal and the Time-Distance signal. The Time-Distance control, when turned from 0 μ s to 1 μ s, lowers the inverted ramp signal that appears at Q340 collector by 5 V. Q340 provides a DC level shift of the U210A output.

Strobe Comparator

The Strobe Comparator (Q550, Q555, CR555, and Q557) compares the Timing Ramp voltage with the Scan Inverter ramp voltage and gives an output pulse (strobe trigger) each time the Timing Ramp voltage becomes more negative than the Scan Inverter ramp voltage.

The Timing Ramp is applied to Q550 base and the Scan Inverter ramp is applied to Q555 base. Q550 conducts as long as its base is positive with respect to Q555 base. Q555 is cut off until its base is positive with respect to Q550 base, at which time it conducts and provides an output pulse which is standardized by CR555 and amplified by Q557. This strobe trigger pulse goes to the 3S7 Sampling Gate.

Fig. 3-5 illustrates the action of the Strobe Comparator. Each time the Timing Ramp runs, a TDR Step Pulse is generated. When the Timing Ramp runs down to the same voltage as the Scan Inverter ramp (and continues to decrease), a Strobe pulse is delivered and a sample of the TDR Step Pulse waveform is taken.

The Timing Ramp has three ramp slopes that correspond to the X10, X1, and X.1 positions of the Magnifier switch (part of the Time/Div switch). The Scan Inverter ramp has up to nine ramp amplitudes that correspond to the Time/Div magnification of 1 to 500 in a 1-2-5 sequence. The time window that is used by the CRT is controlled by the combinations of the Timing Ramp and the Scan Inverter ramp. A high Time/Div magnification uses a very small Scan Inverter ramp amplitude.

To understand how the time window is changed, assume that the TDR pulse starts inside the left edge of the graticule and the last sample of Fig. 3-4 is inside the right edge of the graticule, to obtain approximately ten divisions of display. If the Scan Inverter ramp amplitude is decreased from -5 V to -1 V, each sample moves towards the leading edge of the TDR pulse and the time/sample is decreased five times. Since the drive to the CRT from the Scan Ramp has not been attenuated, the apparent sweep rate has been increased by a factor of five. Thus, attenuation of the Scan Inverter ramp results in a Time/Div magnification.

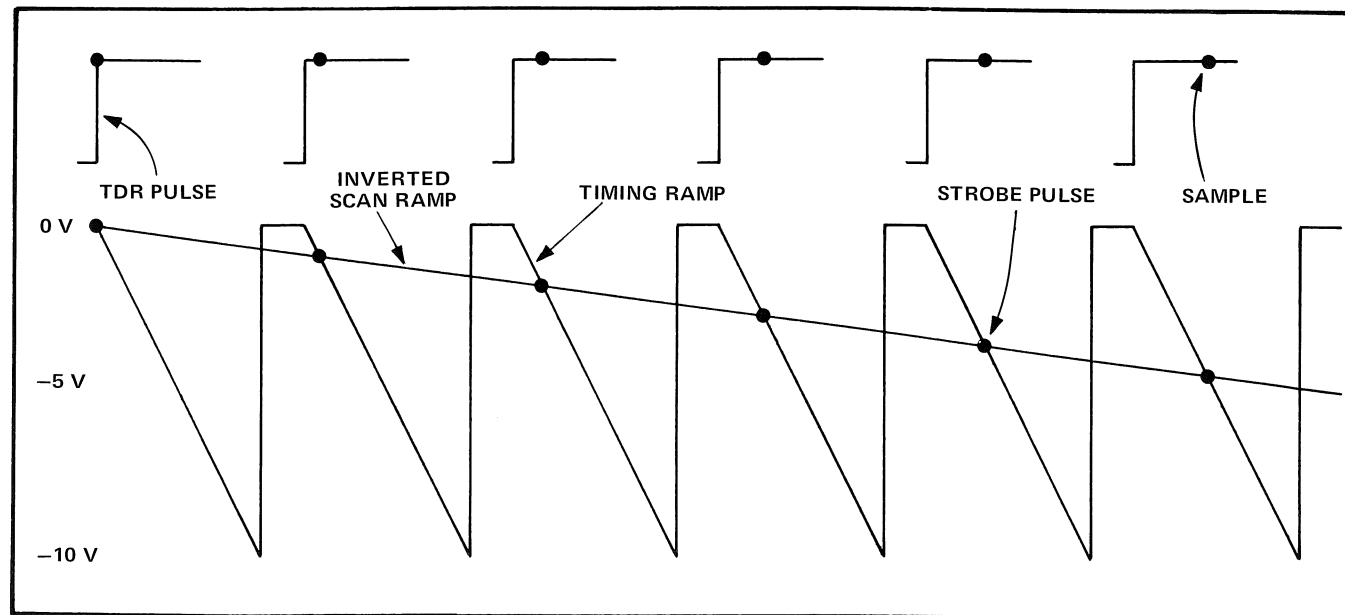

Fig. 3-5. TDR pulse sampling as related to the coincidence of the inverted scan ramp and the timing ramp.

CRT Driver

The CRT Driver includes Q245 and Q255. The gain of the amplifier is set by the Sweep Calibration control R250 (screwdriver adjust) so that the 0 V to 10 V Scan voltage as delivered by the counterclockwise to clockwise rotation of the Scan control in the Manual mode gives a 10 division deflection of the beam on the CRT. R258 is the front panel trace Horizontal Position control (screwdriver adjust).

SCAN RESET OPERATION

At the completion of each scan (sweep), the following circuits reset the trace.

Scan Ramp Reset Multivibrator

The Scan Ramp Reset Multivibrator (Q280, Q275, and U270C) resets the Scan Ramp via the Blanking Amplifier after the Scan Ramp runs up to 10.2 V (see Fig. 3-6). Q280 and Q275 form a Schmitt Multivibrator, and U270C drives the Blanking Amplifier.

When the Scan Ramp reaches +10.2 V, the voltage turns off Q280 (via CR282). Q280 emitter voltage changes to +5 V from +10.2 V when Q275 turns on. U270C emitter switches from -12 V to 0 V and this signal goes through R268 and CR268 to the Blanking Amplifier. The emitter signal also turns on Q405 in the Period Multivibrator to stop and hold the Period Multivibrator in its low state during the scan reset. After a period of time, C282 discharges to +5 V and Q280 turns on. Q280 emitter goes to

+10.2 V, and Q275 collector and U270C base return to -12.2 V. The Period Multivibrator then cycles again.

Blanking Amplifier

The Blanking Amplifier (Q260 and Q265) functions as a multivibrator for the Single Sweep mode of operation, and as an amplifier for the other three modes. It provides a CRT blanking pulse and a Scan Ramp reset pulse each time the Scan Ramp Reset Multivibrator turns on.

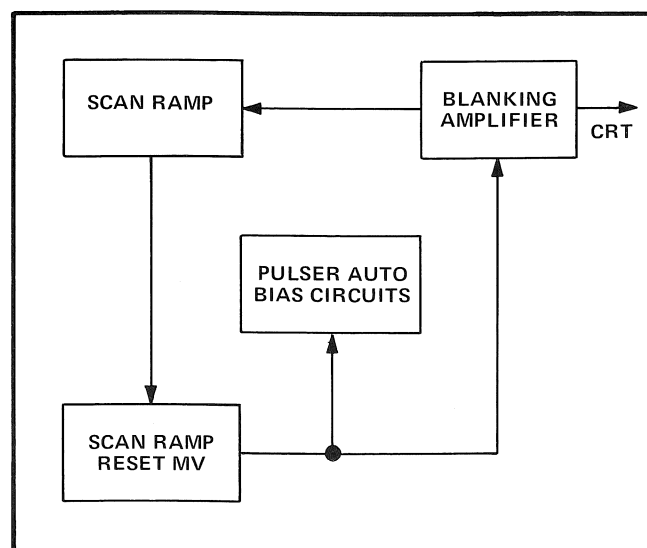

Fig. 3-6. 3S7 TDR Sweep Scan Reset circuit block diagram.

The positive pulse from the Scan Ramp Reset Multivibrator charges C266 and turns on Q265, which provides the negative CRT blanking pulse. Q260 collector rises to 0 V and turns on Q200 in the Scan Ramp to discharge C200. When the Scan Ramp Reset Multivibrator changes state, U270C goes back to -12.2 V. Q260 and Q265 then turn off after a delay period set by C266 and R266. This delay period is lengthened by the addition of C267, which is connected in parallel with C266 in the High Resolution mode. Q265 turns off when C266 charges below -12 V. When Q260 collector goes to -12 V, Q200 turns off, and the Scan Ramp starts running positively again.

In Single Sweep operation, Q260 collector is connected to Q265 base by R260 to form a monostable multivibrator. The multivibrator is turned off only when the START button is pushed. The button grounds one side of charged C265 to apply a negative voltage to Q265 base, to momentarily turn it off and allow a scan.

AUTOMATIC PULSER BIAS ADJUST

The automatic Pulser bias adjust operation is performed during the scan reset interval. The following circuits accomplish the bias adjustment (see Fig. 3-7).

Memory Reset Multivibrator

The Memory Reset Multivibrator (U270D and Q430) resets the Pulser Memory, the Level Sense Multivibrator, and the Pulser, via the Reset, when the Scan Ramp Reset

Multivibrator triggers it on through R433 and C433 at the end of each scan.

After conducting for 60 μ s, the Memory Reset Multivibrator turns itself off, since it is AC coupled. The positive pulse from Q430 collector turns on Q435 in the Pulser Bias Level Memory to discharge memory capacitor Q435. The negative pulse from U270D collector, through R425 to U270A base, turns on the Reset, to reset the Pulser. The positive pulse from Q430 collector through C430 switches the Level Sense Multivibrator to its high state.

Level Sense Multivibrator

The Level Sense Multivibrator (U395A) is a bistable multivibrator that turns the Memory Current Gate on and off. At the end of the scan the Memory Reset Multivibrator pulse through C430 to the +input of the Level Sense Multivibrator switches the output from -2 V to +14 V to turn on U270E in the Memory Current Gate. When in this state, the Level Sense Multivibrator +input is set at +0.4 V and the Level Sense Multivibrator acts as a level sensing device. As long as the Pulser tunnel diode voltage state is below this level, the Level Sense Multivibrator stays in the high state. When the tunnel diode goes to the high state, the Level Sense Multivibrator switches negative and stays there, ignoring further tunnel diode switching.

Memory Current Gate

The Memory Current Gate (U270E, Q437, and Q445) supplies current to the Pulser Memory and a pulse to the Reset to reset the Pulser. The positive pulse from the Level Sense Multivibrator turns on U270E, which forward biases Q437 through CR437. The current from R437 then flows through Q437 to the Pulser Memory. U270E turns off when the Level Sense Multivibrator switches back to its low level after the Pulser switches to its high state. The current to the Pulser Memory then is stopped. When U270E turns off, its collector voltage rises until CR444 conducts and Q445 turns on. C448 and R448 couple the negative Q445 collector pulse to U270A and B, resetting the Pulser to its low state.

Pulser Memory

The Pulser Memory provides bias current for the Pulser tunnel diode so that it will operate properly. Q438 and Q440 with C435 form a Miller integrator. Its output voltage is proportional to the charge conducted to its input from the Memory Current Gate.

The Pulser Memory is first reset to zero output by the Memory Reset Multivibrator, which briefly pulses on Q435 in the Pulser Memory to discharge capacitor C435. The Q440 output voltage begins to rise as the integrator receives

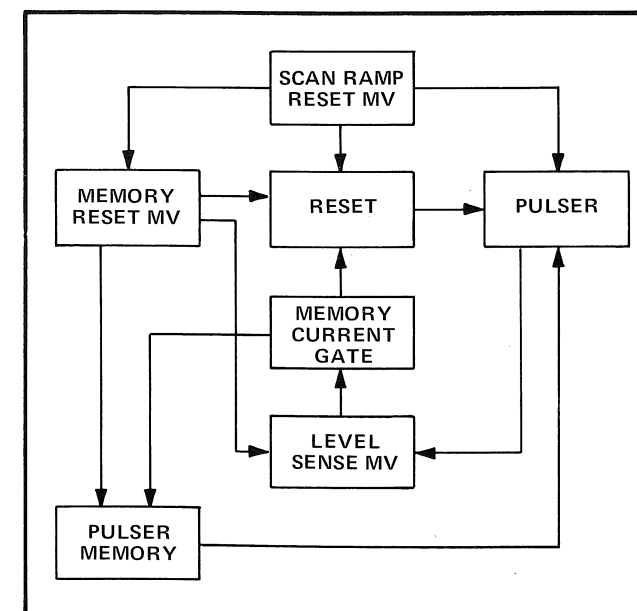

Fig. 3-7. 3T7 TDR Sweep Automatic Pulser Bias circuit block diagram.

current from the Memory Current Gate. When the output voltage rises sufficiently, the combined currents through R442 and R457 reach the tunnel diode trigger current level (I_p) and switches it to the high state. The Level Sense Multivibrator output then goes negative, the Memory Current Gate stops conducting and with no more input current from the Memory Current Gate, the Pulser Memory output voltage stops rising and remains fixed during the following CRT scan. At the end of the Scan Reset Multivibrator hold-off period, the emitter of U270C goes from 0 V to -12.6 V and removes a small amount of current from the Pulser tunnel diode bias through R455 to switch the tunnel diode to its low state.

LOCATE CIRCUIT

The Locate circuit, see Fig. 3-8, permits the operator to locate the delayed sampled time window with respect to the unmagnified test pulse. The delayed sampled time window appears as the intensified portion of a X0.5 magnified trace when the LOCATE button is pushed.

To obtain an intensified trace, there must be outputs from the dual differential Darlington amplifier U345 pins 4

and 6 at the same time. The current through R345 normally holds Q350 off. When current is received from both pins 4 and 6, the hold off current through R345 is overcome and Q350 conducts, driving the CRT intensify circuit. This circuit forms an "and" logic element. When Q350 is not conducting, the trace intensity is decreased. This condition is found only when the voltage at the base inputs at pins 5 and 10 is a value between the voltages at pins 8 and 11.

The voltage at pin 11 is determined by the amount of Time-Distance position current delivered to U210B when the Locate button is pushed. This voltage level corresponds to the level at which the time window starts when the Locate button is released. The voltage at pin 8 is set by a resistor selected at the Time/Div switch, and is programmed to represent the lower voltage level of the time window during the time the Locate button is not pushed.

When the Locate button is pushed, the Scan Ramp Inverter is driven through a fixed 10 k Ω resistor instead of through the Time/Div attenuator. Thus, the CRT scan represents the total time window range available for a selected Time-Distance Multiplier supplying an output ramp length of 10 V.

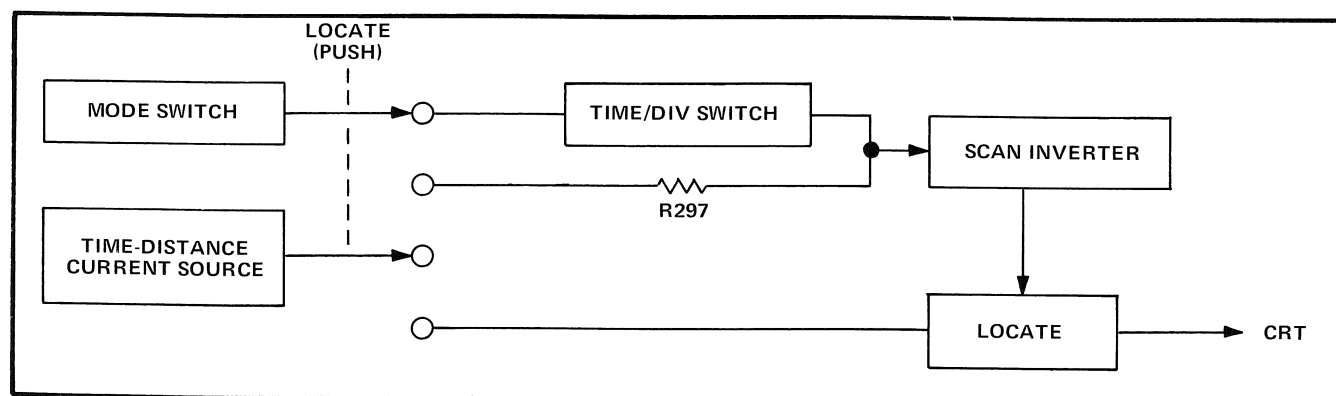

Fig. 3-8. 3T7 TDR Sweep Locate circuit block diagram.

SECTION 4 MAINTENANCE

Change information, if any, affecting this section will be found at the rear of this manual.

Introduction

This section of the manual contains maintenance information for use in preventive maintenance, corrective maintenance or troubleshooting of the 3S7/3T7.

PREVENTIVE MAINTENANCE

General

Preventive maintenance consists of cleaning, visual inspection, lubrication, etc. Preventive maintenance performed on a regular basis will help prevent instrument failure. The severity of the environment to which the units are subjected will determine the frequency of maintenance.

Cleaning

The units should be cleaned as often as operating conditions require. Accumulation of dirt in the instrument can cause overheating and component breakdown. Dirt on components acts as an insulating blanket and prevents efficient heat dissipation. It also provides an electrical conduction path.

The best way to clean the interior is to blow off the accumulated dust with dry, low-velocity air. Remove any dirt which remains with a soft paint brush or a cloth dampened with a mild detergent and water solution.

CAUTION

Avoid the use of chemical cleaning agents which might damage the plastic used in this instrument. Some chemicals to avoid are benzene, toluene, xylene, acetone or similar solvents.

Lubrication

The reliability of potentiometers, rotary switches and other moving parts can be increased if they are kept properly lubricated. Use a cleaning-type lubricant (such as Tektronix Part No. 006-0218-00) on switch contacts. Lubricate switch detents with a heavier grease (such as Tektronix Part No. 006-0219-00). Potentiometers should be lubricated with a lubricant which will not affect elec-

trical characteristics (such as Tektronix Part No. 006-0220-00). Do not over-lubricate. A lubrication kit containing the necessary lubricants and instructions is available from Tektronix. Order Tektronix Part No. 003-0342-00.

Visual Inspection

The units should be inspected occasionally for such defects as broken connections, improperly seated transistors, damaged circuit boards and heat-damaged parts.

The remedy for most visible defects is obvious; however, care must be taken if heat-damaged parts are located. Overheating is usually only a symptom of trouble. For this reason, it is essential to determine the actual cause of overheating before the heat-damaged parts are replaced; otherwise, the damage may be repeated.

Calibration

To ensure accurate measurements, check the calibration of this instrument after each 500 hours of operation or once every six months.

MAINTENANCE INFORMATION

Switch Wafer Identification

Wafers of switches shown on the circuit diagram are numbered from the first wafer located behind the detent section of the switch to the last wafer. The letters F and R indicate whether the front or the rear of the wafer is used to perform the particular switching function. For example, the designation 2R printed by a switch section on a schematic identifies the switch section as being on the rear side of the second wafer when counting back from the front panel.

Parts Replacement

All parts used in the units may be purchased directly through your Tektronix Field Office or representative. However, replacements for standard electronic items can generally be obtained locally in less time than is required to

current from the Memory Current Gate. When the output voltage rises sufficiently, the combined currents through R442 and R457 reach the tunnel diode trigger current level (I_p) and switches it to the high state. The Level Sense Multivibrator output then goes negative, the Memory Current Gate stops conducting and with no more input current from the Memory Current Gate, the Pulser Memory output voltage stops rising and remains fixed during the following CRT scan. At the end of the Scan Reset Multivibrator hold-off period, the emitter of U270C goes from 0 V to -12.6 V and removes a small amount of current from the Pulser tunnel diode bias through R455 to switch the tunnel diode to its low state.

LOCATE CIRCUIT

The Locate circuit, see Fig. 3-8, permits the operator to locate the delayed sampled time window with respect to the unmagnified test pulse. The delayed sampled time window appears as the intensified portion of a X0.5 magnified trace when the LOCATE button is pushed.

To obtain an intensified trace, there must be outputs from the dual differential Darlington amplifier U345 pins 4

and 6 at the same time. The current through R345 normally holds Q350 off. When current is received from both pins 4 and 6, the hold off current through R345 is overcome and Q350 conducts, driving the CRT intensify circuit. This circuit forms an "and" logic element. When Q350 is not conducting, the trace intensity is decreased. This condition is found only when the voltage at the base inputs at pins 5 and 10 is a value between the voltages at pins 8 and 11.

The voltage at pin 11 is determined by the amount of Time-Distance position current delivered to U210B when the Locate button is pushed. This voltage level corresponds to the level at which the time window starts when the Locate button is released. The voltage at pin 8 is set by a resistor selected at the Time/Div switch, and is programmed to represent the lower voltage level of the time window during the time the Locate button is not pushed.

When the Locate button is pushed, the Scan Ramp Inverter is driven through a fixed 10 k Ω resistor instead of through the Time/Div attenuator. Thus, the CRT scan represents the total time window range available for a selected Time-Distance Multiplier supplying an output ramp length of 10 V.

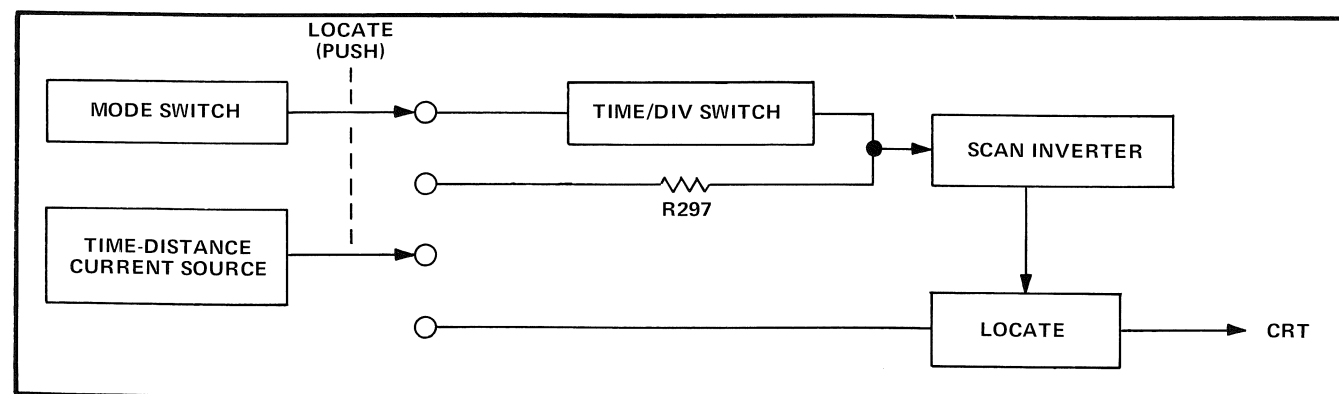

Fig. 3-8. 3T7 TDR Sweep Locate circuit block diagram.

SECTION 4 MAINTENANCE

Change information, if any, affecting this section will be found at the rear of this manual.

Introduction

This section of the manual contains maintenance information for use in preventive maintenance, corrective maintenance or troubleshooting of the 3S7/3T7.

PREVENTIVE MAINTENANCE

General

Preventive maintenance consists of cleaning, visual inspection, lubrication, etc. Preventive maintenance performed on a regular basis will help prevent instrument failure. The severity of the environment to which the units are subjected will determine the frequency of maintenance.

Cleaning

The units should be cleaned as often as operating conditions require. Accumulation of dirt in the instrument can cause overheating and component breakdown. Dirt on components acts as an insulating blanket and prevents efficient heat dissipation. It also provides an electrical conduction path.

The best way to clean the interior is to blow off the accumulated dust with dry, low-velocity air. Remove any dirt which remains with a soft paint brush or a cloth dampened with a mild detergent and water solution.

CAUTION

Avoid the use of chemical cleaning agents which might damage the plastic used in this instrument. Some chemicals to avoid are benzene, toluene, xylene, acetone or similar solvents.

Lubrication

The reliability of potentiometers, rotary switches and other moving parts can be increased if they are kept properly lubricated. Use a cleaning-type lubricant (such as Tektronix Part No. 006-0218-00) on switch contacts. Lubricate switch detents with a heavier grease (such as Tektronix Part No. 006-0219-00). Potentiometers should be lubricated with a lubricant which will not affect elec-

trical characteristics (such as Tektronix Part No. 006-0220-00). Do not over-lubricate. A lubrication kit containing the necessary lubricants and instructions is available from Tektronix. Order Tektronix Part No. 003-0342-00.

Visual Inspection

The units should be inspected occasionally for such defects as broken connections, improperly seated transistors, damaged circuit boards and heat-damaged parts.

The remedy for most visible defects is obvious; however, care must be taken if heat-damaged parts are located. Overheating is usually only a symptom of trouble. For this reason, it is essential to determine the actual cause of overheating before the heat-damaged parts are replaced; otherwise, the damage may be repeated.

Calibration

To ensure accurate measurements, check the calibration of this instrument after each 500 hours of operation or once every six months.

MAINTENANCE INFORMATION

Switch Wafer Identification

Wafers of switches shown on the circuit diagram are numbered from the first wafer located behind the detent section of the switch to the last wafer. The letters F and R indicate whether the front or the rear of the wafer is used to perform the particular switching function. For example, the designation 2R printed by a switch section on a schematic identifies the switch section as being on the rear side of the second wafer when counting back from the front panel.

Parts Replacement

All parts used in the units may be purchased directly through your Tektronix Field Office or representative. However, replacements for standard electronic items can generally be obtained locally in less time than is required to

obtain them from Tektronix. Replacements for the special parts used in the assembly of the units should be ordered from Tektronix since these parts are either manufactured or selected by Tektronix to satisfy a particular requirement. Before purchasing or ordering, consult the Electrical Parts List to determine the value, tolerance and rating required.

NOTE

When selecting the replacement parts, it is important to remember that the physical size and shape of a component may affect its performance at high frequencies. Parts orientation and lead dress should duplicate those of the original part since many of the components are mounted in a particular way to reduce or control stray capacitance and inductance. After repair, portions of the instrument may require recalibration.

Switches. The pushbutton switches are not repairable and should be replaced if defective.

Individual wafers or mechanical parts of rotary switches are normally not replaced. The availability of replacement switches, either wired or unwired, is detailed in the Electrical Parts List.

Circuit Boards

Use ordinary 60/40 solder and a 35- to 40-watt pencil type soldering iron on the circuit boards. The tip of the iron should be clean and properly tinned for best heat transfer to the solder joint. A higher wattage soldering iron may separate the etched wiring from the base material.

Soldered-in Component Replacement

Grip the component lead with long-nose pliers. Touch the soldering iron to the lead at the solder connection. Do not lay the iron directly on the board, as it may damage the board.

When the solder begins to melt, pull the lead out gently. This should leave a clean hole in the board. If not, the hole can be cleaned by reheating the solder and placing a sharp object such as a toothpick or pointed tool into the hole to clean it out.

Bend the leads of the new component to fit the holes in the board. If the component is replaced while the board is mounted in this instrument, cut the leads so they will just protrude through the board.

Pre-tin the leads of the component by applying the soldering iron and a small amount of solder to each (heat-

shunted) lead. Insert the leads into the board until the component is firmly seated against the board. If it does not seat properly, heat the solder and gently press the component into place.

Apply the iron and a small amount of solder to the connection to make a firm solder joint. To protect heat-sensitive components, hold the lead between the component body and the solder joint with a pair of long-nose pliers or other heat sink.

Clean the area around the soldered connection with a flux-remover solvent to remain good environmental characteristics. Be careful not to remove information printed on the board.

Leadless Capacitor Replacement

Leadless capacitors are soldered directly to the circuit board (sometimes through a hole in the board under the capacitor). A low wattage soldering iron should be used on the top side of the capacitor. A higher wattage soldering iron should be used for the bottom side of the capacitor. Do not apply the soldering iron to the circuit board any longer than necessary to minimize the chance of damage of the circuit board. Excessive solder may short-out the capacitor at its edge.

Troubleshooting Techniques

This troubleshooting procedure is arranged in an order which checks the simple trouble possibilities before proceeding with extensive troubleshooting. The first few checks ensure proper connection, operation and calibration. If the trouble is not located by these checks, the remaining steps aid in locating the defective component. When the defective component is located, it should be replaced, following the replacement procedure given in this section.

1. Check Control Settings. Incorrect control settings can indicate a trouble that does not exist. For example, incorrect setting of the VARIABLE control appears as incorrect gain, etc. If there is any question about the correct function or operation of any control, see the Operating Instructions section of this manual.

2. Check Associated Equipment. Before proceeding with troubleshooting of the units, check that the equipment used with the units is operating correctly. Check that the signal is properly connected and that the interconnecting cables are not defective. Also, check the power source.

3. Visual Check. Visually check the portion of the instrument in which the trouble is located. Many troubles

can be located by visual indications such as unsoldered connections, broken wires, damaged circuit boards, damaged components, etc.

4. Check Instrument Calibration. Check the calibration of the instrument, or the affected circuit if the trouble exists in one circuit. The indicated trouble may only be a result of misadjustment or may be corrected by calibration. Complete instructions are given in the Calibration section of this manual.

5. Isolate the Trouble to a Circuit. To isolate trouble to a circuit, note the trouble symptom. The symptom often identifies the circuit in which the trouble is located. When trouble symptoms appear in more than one circuit, check affected circuits by taking voltage and waveforms readings.

6. Check Individual Components. The following procedures describe methods of checking components. Components which are soldered in place should first be isolated by disconnecting one end.

A. SEMICONDUCTORS

CAUTION

Power switch must be turned off before removing or replacing semiconductors.

To check a transistor, substitute another which is known to be good. If substitute transistors are not available, use a dynamic tester. Static-type testers are not recommended, since they do not check for dynamic operation.

B. DIODES

A diode can be checked for an open or shorted condition by measuring the resistance between terminals. Using an ohmmeter having an internal source of between 800 millivolts and 3 volts, the diode resistance should be very high in one direction and very low when the meter leads are reversed.

CAUTION

Do not use an ohmmeter scale that involves the supply of large internal current to the diode. (For this use, avoid the lower ranges, such as RX1 and RX10.)

C. RESISTORS

Check the resistors with an ohmmeter. See the Electrical Parts List for the tolerance of the resistors used in this

instrument. Resistors normally do not need to be replaced unless the measurement value varies widely from the specified value.

D. INDUCTORS

Check for open inductors by checking continuity with an ohmmeter. Shorted or partially shorted inductors can usually be found by checking the waveform response when high-frequency signals are passed through the circuit. Partial shorting often reduces high-frequency response.

E. CAPACITORS

Use an ohmmeter (high resistance scale) to check a capacitor for leakage or short-circuit. Do not exceed the voltage rating of the capacitor. The resistance reading should be high after initial charge of the capacitor. An open capacitor can best be detected with a capacitance meter or by checking whether the capacitor passes AC signals.

7. Repair and Readjust the Circuit. If any defective parts are located, follow the replacement procedures given in this section. Be sure to check the performance of any circuit that has been repaired.

Resistor Color Code

In addition to the composition resistors, some metal-film resistors are used in these instruments. Nearly all resistors are color-coded for resistance value and tolerance using EIA color code (a metal-film resistor may have the value printed on the body). Composition resistors have four stripes which represent two significant figures, the multiplier and the tolerance value (see Fig. 4-1). Metal-film resistors have five stripes which represent three significant figures, the multiplier and the tolerance value.

Capacitor Marking

The capacitance of a disc or electrolytic capacitor is marked in microfarads on the side of the component body. The leadless capacitors are not marked.

Diode Color Code

The cathode end of each glass-encased diode is indicated by a stripe, a series of stripes or a dot. For most striped diodes, the color code identifies the unique portion of the Tektronix Part number using the EIA color-code system (e.g., a diode color-coded pink-, or blue-, brown-gray-green indicates Tektronix Part Number 152-0185-00).

Wiring Color Code

All insulated conductors in these instruments are color-coded as noted in Fig. 4-1.

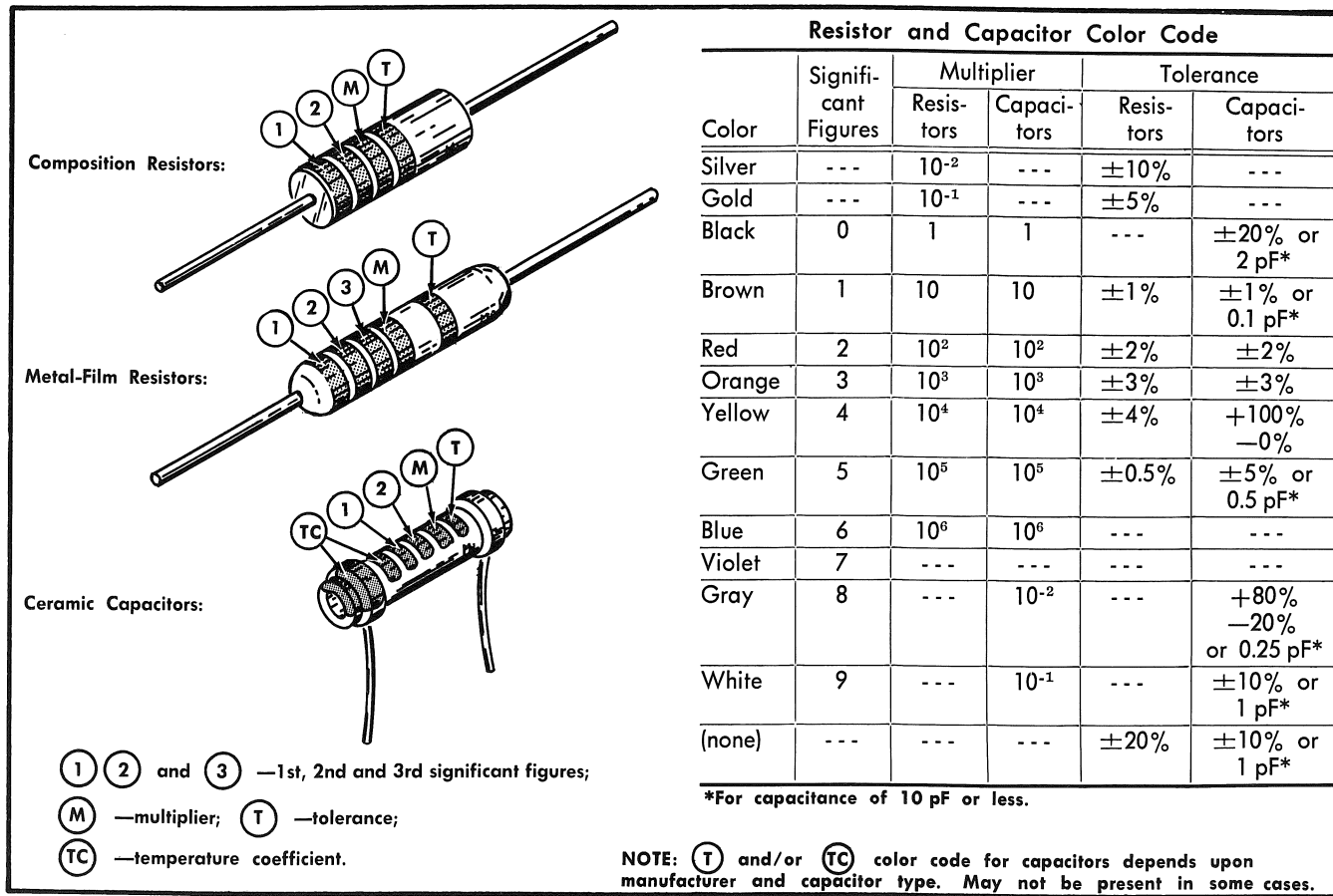

Fig. 4-1. Standard EIA color coding for resistors and capacitors.

Semiconductor Lead Configuration

Fig. 4-2 shows the lead configuration of semiconductors used in these instruments. This view is from the bottom of the semiconductors.

Gate Diodes Replacement

The Gate diodes (CR6 and CR12) are mounted in a white plastic holder that slides into a cutout in the edge of the Vertical board. The holder is located behind the TEST LINE connector. The holder may be pulled out with a pair of needle-nose pliers or forceps. To replace the holder, press it into the slot so that it is flush with the edge of the board.

Capacitor C18 Replacement

When replacing capacitor C18 after the shields are removed, note into which holes the stator and rotor leads are inserted. The electrical performance is adversely affected if the capacitor is inserted wrong.

Vertical Board Removal and Replacement

1. Remove the two 12-sided nuts that secure the GR connectors to the front panel. A special Tektronix tool is available for removing the 12 sided nuts. Order: 12 sided nut wrench, Tektronix Part No. 003-0459-00.

2. Disconnect the four color-coded cable connectors and the coaxial plug from the circuit board and move the cables away from the circuit board.

3. Remove the two screws that support the rear of the circuit board.

4. Slide the circuit board towards the rear to free the GR connectors. Lift up on one side of the circuit board to remove it from the unit after sliding the board to one side between the chassis and the chrome rail.

5. Circuit board replacement is accomplished by reversing the procedure. Note: Tighten the two rear screws last.

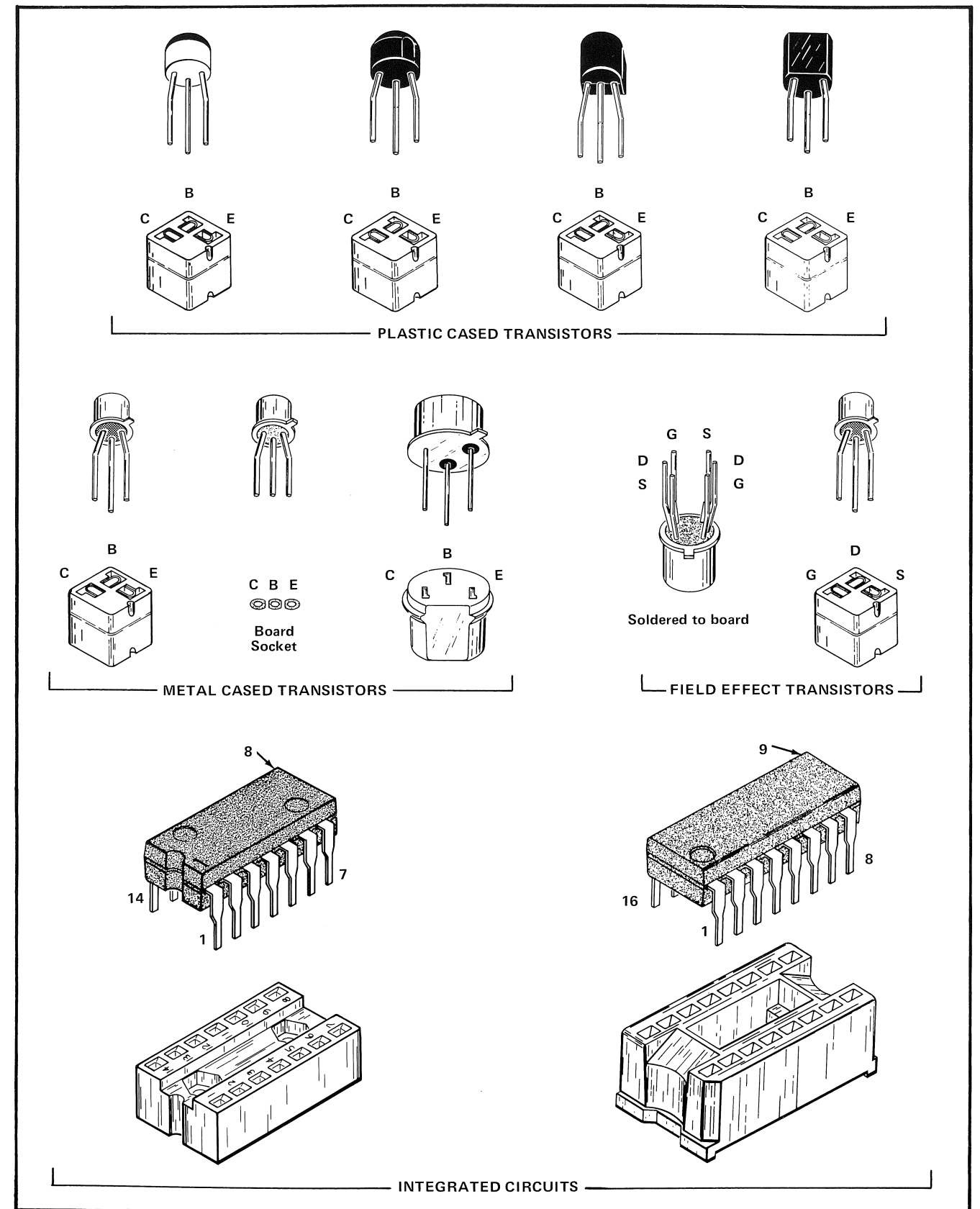

Fig. 4-2. Lead configuration of transistors and integrated circuits.

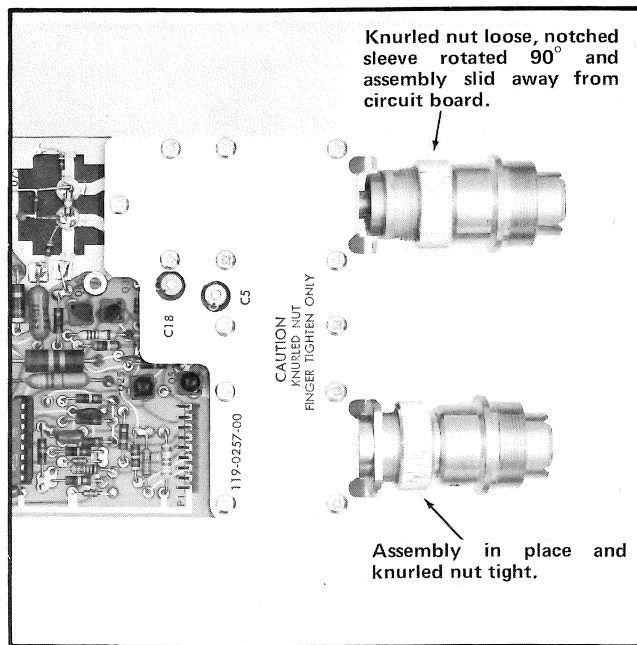

Fig. 4-3. Vertical board GR connector assembly.

Removal of Vertical Board Shields

1. Remove the Vertical circuit board assembly from the Sampler. Loosen the knurled nuts on the GR connectors. See Fig. 4-3. This frees the shield fingers from the notches in the connector sleeves.

2. Rotate the notched connector sleeves 90°, and slide the connector assembly away from the circuit board.

3. Remove the eleven nuts and screws that hold the shields in position to expose that portion of the circuit board.

Vertical Board Shields Replacement

The parts must be reassembled properly to maintain the 50 Ω impedance through the transition from the GR connector to the circuit board. Failure to follow this procedure results in poor ground connection, poor displays and pulse flatness deviations.

1. Install the shields in their proper position on the circuit board. Keep the nuts loose so that the shields have freedom of movement.

2. Slide the GR connectors onto their center conductors mounted on the circuit board. The circuit board edge fits into the notches on the connector when fully installed.

3. Rotate the notched sleeves 90° and mate the notches with the shield fingers.

4. Finger-tighten the knurled nuts of the connector so that the shields and connectors make good contact. Push the circuit board towards the connector shield assembly.

5. Tighten the nuts on the shield.

Pulser Removal and Replacement

1. Note the angle at which the Pulser is installed, so that it can be installed again at the same angle.

2. Remove the 12-sided nut that secures the GR connector to the Sweep front panel. A special Tektronix tool is available for removing the 12-sided nuts. Order: 12-sided nut wrench, Tektronix Part No. 003-0459-00.

3. Disconnect the four connectors on the cable to the Pulser from the Sweep board and remove the Pulser and cable.

4. To replace, reverse this procedure.

Pulser Shield Removal

1. After the Pulser has been removed from the unit, loosen the knurled nut on the GR connector. This is similar to Fig. 4-1. This frees the shield fingers from the notches in the connector sleeve.

2. Rotate the notched connector sleeve 90° and slide the connector assembly away from the circuit board.

3. To expose the circuit board, remove the four nuts and screws that hold the shields in position. It is not necessary to remove the coaxial connector from the one shield. Note that the tip of the coaxial cable center conductor through the shield is capacitively coupled (does not touch) to the end of the tubular resistor, which is inserted in the white plastic support. This is capacitor C587.

Pulser Shield Replacement

The parts must be reassembled properly to maintain the 50 Ω impedance through the transition from the GR connector to the circuit board. Failure to follow this procedure results in poor ground connection, poor displays and pulse flatness deviation.

1. Loosen the coaxial connector on the shield one-half turn with a one-fourth inch wrench.

2. Install the shields in their proper positions on the circuit board. Keep the nuts slightly loose so that the shields have freedom of movement.

3. Slide the GR connector onto the center conductor mounted on the circuit board. The circuit board edge fits into the notches on the connector when fully installed.

4. Rotate the notched sleeve 90° and mate the notches with the shield fingers.

5. Finger-tighten the knurled nut of the connector so that the shields and connector make good contact.

6. Tighten the four nuts on the shield. Push the circuit board towards the connector shield assembly.

7. Install the Pulser in the Sweep.

8. Connect the Sweep to the oscilloscope with an extender cable.

9. Connect the 20-inch coaxial cable from the Sweep PULSE OUT connector to the Sampler PULSE IN connector.

10. Connect a 50-Ω termination to the Sampler TEST LINE connector.

11. Set the Sampler TIME-DISTANCE Multiplier switch at X1 and the TIME/DIV switch at 500 ps. Display the pulse waveform.

12. Turn the coaxial connector on the Pulser shield clockwise until the pulse waveform is distorted (C587 is shorted) and then back off to obtain the normal pulse waveform. Note that the waveform is also distorted if the coaxial connector has been loosened too far in the first step.

13. The coaxial connector lock nut should be tightened.

Tunnel Diode Removal and Replacement

1. Remove the Pulser shields.

2. Note that the tunnel diode (CR587) is mounted on a support with fingers that contact each shield.

3. The tunnel diode is removed by pulling the tunnel diode release cable (braided wire).

4. To replace, reverse this procedure. Note: Position the tunnel diode so that the tunnel diode goes towards the GR connector when installing.

NOTES

SECTION 5 PERFORMANCE CHECK

Change information, if any, affecting this section will be found at the rear of this manual.

Introduction

This section of the manual provides a means of rapidly checking the performance of the Time Domain Reflectometer. It is intended to check the calibration of the instrument without the need for performing the complete Calibration Procedure. The Performance Check does not provide for the adjustment of any internal controls. Failure to meet the requirements given in this procedure indicates the need for internal checks or adjustments, and the user should refer to the Calibration procedure in this manual.

Recommended Equipment

The following equipment is recommended for a complete performance check. Specifications given are the minimum necessary to perform this procedure. All equipment is assumed to be calibrated and operating within the original specifications of the recommended equipment.

1. Oscilloscope. Type 561B or other model in which the Time Domain Reflectometer is intended to be used. Section 1 Introduction lists all models.
2. Oscilloscope. Type 560-series with a Type 3A7 Differential Comparator and a Type 2B67 Time Base. The minimum vertical deflection factor requirement is 10 mV/div. The maximum sweep rate requirement is 10 μ s/div. A Type 547 Oscilloscope with a Type W Differential Comparator may be used.
3. Time Mark Generator, Tektronix 2901. The marker requirements are 1 μ s with submultiples through 2 ns periods within .3%. The trigger output requirement is 10 μ s period triggers.
4. Calibrator. 50 Ω Amplitude Calibrator, Tektronix Calibration Fixture 067-0508-00. The signal amplitude requirements are 30 mV and multiples through 600 mV within 0.25%.
5. Air Line. GR 20-cm length, 50 Ω impedance. Tektronix Part No. 017-0084-00.
6. Cable. 20-inch Coaxial Cable Assembly. Tektronix Part No. 017-0515-00.

7. Cable. 50 Ω coaxial cable at least 3 feet long with BNC connectors. Tektronix Part No. 012-0057-01.

8. Cable. Plug-in Unit Extension Cable. Tektronix Part No. 012-0064-00. The item is not required if the TDR Oscilloscope right side panel is removed.

9. Test lead. Meter test lead having a probe and a banana plug at opposite ends.

10. Probe. 1X attenuation P6011. Tektronix Part No. 010-0193-00.

11. Probe. 10X attenuation, P6012. Tektronix Part No. 010-0202-00.

12. Adapter. GR to BNC female connector. Tektronix Part No. 017-0063-00.

13. Termination. GR short. Tektronix Part No. 017-0081-00.

14. Resistor. 10 k Ω , 0.25%.

15. Resistor. 100 k Ω 1%.

PERFORMANCE CHECK PROCEDURE

General

In the following procedure, test equipment connections or control settings should not be changed except as noted. If only a partial check is desired, refer to the preceding step(s) for setup information.

The following procedure uses the equipment listed under Recommended Equipment. If substitute equipment is used, control setting or setup must be altered to meet the requirements of the equipment used.

Preliminary Procedure

a. Install the Sampler in the Vertical (left) and the Sweep in the Horizontal (right) compartments of the 561B Oscilloscope.

b. Turn the power ON to the TDR and test oscilloscopes, the 50 Ω Amplitude Calibrator and the 2901 Time Mark Generator. Allow a 5 minute warmup.

c. Connect a 50 Ω termination to the Sampler TEST LINE connector.

d. Set the Sampler controls.

UNITS mV
 UNITS/DIV 100
 RESOLUTION NORMAL
 POLARITY +UP
 DC OFFSET midrange

e. Set the Sweep controls.

PRESET right position
 TIME/DIV 1 μs
 TIME-DISTANCE 0
 FINE fully clockwise
 SCAN MODE REPETITIVE
 VARIABLE OR EXT ATTEN fully clockwise

f. Connect a 20 inch coaxial cable from the 50 Ω Amplitude Calibrator to the Sampler PULSE IN connector.

g. Set the 50 Ω Amplitude Calibrator Volts switch at .6 and the DC-Square Wave switch at DC. This is a negative voltage.

h. Set the Sampler trace 3 div below graticule center.

i. Turn the 50 Ω Amplitude Calibrator Power OFF and adjust the Sampler GAIN control (if necessary) for a 6 div (600 mV) trace rise. Turn the 50 Ω Amplitude Calibrator Power ON and repeat the previous step and this step as necessary to obtain a 6 div trace shift.

j. Disconnect the coaxial cable from the Sampler and the 50 Ω Amplitude Calibrator. Keep the Calibrator Power ON.

k. Set the Sweep Scan Mode switch at MANUAL.

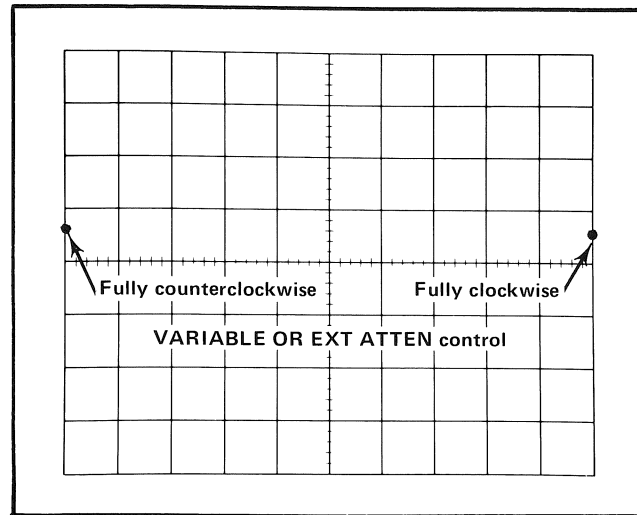

Fig. 5-1. The correct dot range of movement for the MANUAL scan operation.

l. Adjust the SWEEP CAL and HORIZ POS controls so that the dot is at graticule line zero (extreme left vertical line) with the Sweep VARIABLE OR EXT ATTEN control fully counterclockwise and is at graticule line ten (extreme right vertical line) with the control fully clockwise. See Fig. 5-1 which shows the correct range of the dot movement. The SWEEP CAL control sets the distance the dot moves and the HORIZ POS control positions the dot range of movement on the CRT face.

m. Set the Sweep SCAN MODE switch at REPETITIVE.

n. Remove the right side panel from the TDR Oscilloscope to gain access to test point TP407 on the Sweep board. An alternative to the side panel removal is to insert an Extender Cable (Tektronix Part No. 012-0066-00) between the Sweep and the oscilloscope.

SYSTEM CHECKS

1. Check TIME/DIV Accuracy

a. Connect a BNC coaxial cable from the 2901 Time Mark Generator Marker Out connector to the Sampler PULSE IN connector by using a GR to BNC female adapter.

b. Connect the P6012 (10X) Probe BNC connector end to the Time Mark Generator Trigger Out connector and the probe tip to test point TP407 on the Sweep board. TP407 is located in the center of the circuit board above TP420. See A3 Sweep Circuit Board callouts or Fig. 6-1 for TP407 location.

c. Push the Time Mark Generator Marker Selector 1 μs button and the Trigger Selector 10 μs button.

The accuracy of the 500, 200 and 100 ps/div ranges is checked indirectly since the timing resistors are also used in other TIME/DIV switch positions.

2. Check VARIABLE TIME/DIV Range

a. Set the Sweep TIME/DIV control at 1 μs and the TIME-DISTANCE control at 0 μs.

b. Set the Time Mark Generator Marker Selector at 1 μs.

c. Adjust the Sweep FINE control to position the 1 μs marks at the graticule lines.

d. Turn the VARIABLE TIME-DISTANCE control (red knob) fully clockwise.

e. CHECK that the 1 μs markers are at least 2.5 div apart. This corresponds to a decrease in the time/div of at least 2.5:1.

f. Place the VARIABLE TIME-DISTANCE control at CAL.

3. Check TIME-DISTANCE Scale Accuracy

a. Set the TIME-DISTANCE control at 0 μs and adjust the FINE control (if necessary) to place the 1 μs markers at the graticule lines.

b. Select graticule line 5 as a reference and turn the TIME-DISTANCE control to place the 10th marker from line 5 at line 5.

c. CHECK that the TIME-DISTANCE control is at 1.00 μs (within 0.01 μs).

4. Check FINE (ZERO SET) Control Range

a. Set the Sweep FINE control fully counterclockwise and the TIME-DISTANCE control at zero.

b. Adjust the TIME-DISTANCE control to position the 1 μs markers at the graticule lines.

c. Turn the FINE control fully clockwise.

d. CHECK that the markers move at least 1 major division. This corresponds to at least 10% of the TIME-DISTANCE range.

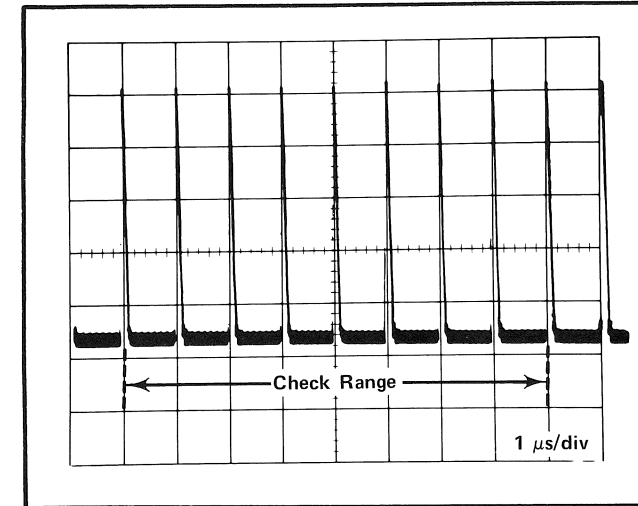

Fig. 5-2. Correct TIME/DIV check range. One μs markers are shown (Steps 1 through 5).

d. CHECK the accuracy of the TIME/DIV switch from graticule line 1 to graticule line 9 using the control settings indicated for the Sampler and the Time Mark Generator. The last column indicates the maximum permissible error. The check should be made at each end of the TIME-DISTANCE control range. Adjust the Sweep SAMPLING RATE control as necessary to obtain a triggered waveform. See Fig. 5-2 which shows the first check.

Table 1

TIME/DIV	TIME-DISTANCE Multiplier	Marker Selector (input signal)	Maximum Error (8 div, %)
1 μs	X10	1 μs	.24 div, 3%
500 ns	X10	.5 μs	.24 div, 3%
200 ns	X10	.1 μs	.24 div, 3%
100 ns	X10	.1 μs	.36 div, 4.5%
50 ns	X10	50 ns	.36 div, 4.5%
20 ns	X10	10 ns	.36 div, 4.5%
10 ns	X10	10 ns	.48 div, 6%
5 ns	X10	5 ns	.48 div, 6%
2 ns	X10	2 ns	.48 div, 6%
100 ns	X1	.1 μs	.24 div, 3%
50 ns	X1	50 ns	.24 div, 3%
20 ns	X1	10 ns	.24 div, 3%
10 ns	X1	10 ns	.36 div, 4.5%
5 ns	X1	5 ns	.36 div, 4.5%
2 ns	X1	2 ns	.36 div, 4.5%
1 ns	X1	2 ns	.48 div, 6%
10 ns	X.1	10 ns	.24 div, 3%
5 ns	X.1	5 ns	.24 div, 3%
2 ns	X.1	2 ns	.24 div, 3%
1 ns	X.1	2 ns	.36 div, 4.5%

5. Check PRESET Control Range

- a. Set the Sweep controls.

PRESET	left position
PRESET screwdriver adjust	fully clockwise
TIME/DIV	1 μ s
TIME-DISTANCE	0

- b. Adjust the FINE control to position the 1 μ s markers at the graticule lines.

- c. Select graticule line 5 as a reference and turn the TIME-DISTANCE control to place the 10th marker from line 5 at line 5 (or slightly past).

- d. CHECK that the TIME-DISTANCE control is at 1.00 μ s. This verifies the polyethylene dielectric limit of the PRESET control range.

- e. Set the TIME-DISTANCE control at 0 μ s.

- f. Set the PRESET (screwdriver adjust) control fully counterclockwise.

- g. CHECK that the marker at graticule line 8 moves not more than 6.6 div to the left when the TIME-DISTANCE control is turned to 1.00 μ s. This verifies the air dielectric limit of the control range.

- h. Set the PRESET switch at the right position.

- i. Disconnect the probe from the test point and the Time Mark Generator.

- j. Disconnect the coaxial cable with the adapter from the Sampler.

6. Check SWEEP OUT Voltage

- a. Set the Sweep SCAN MODE switch at MANUAL.

- b. Turn the Sweep VARIABLE OR EXT ATTEN control fully counterclockwise.

- c. Set the Differential Comparator controls.

V_C Range	0
Comparison Voltage	100
A Input	DC
A Input Atten	1
Millivolts/Div	50
Display	A- V_C

- d. Connect a P6011 (1X) Probe from the Differential Comparator A Input to the SWEEP OUT connector. Use a retractable hook tip on the probe and a banana plug to attach the probe to the connector.

- e. Position the test oscilloscope free running trace at graticule center.

- f. Turn the Sweep VARIABLE OR EXT ATTEN control fully clockwise.

- g. Set the Differential Comparator V_C Range switch at +11.

- h. CHECK that a comparison voltage of 10 V (within .5 V) recenters the trace. This corresponds to an output voltage of 1 V/div (within 5%).

- i. Remove the probe tip from the SWEEP OUT connector.

7. Check SWEEP OUT Source Resistance

- a. Set the Differential Comparator V_C Range switch at 0.

- b. Ground the probe tip and center the test oscilloscope trace.

- c. Set the Differential Comparator V_C Range switch at +1.1 and the Comparison Voltage at 1 V.

- d. Connect the probe to the SWEEP OUT connector and adjust the VARIABLE OR EXT ATTEN control to recenter the test oscilloscope trace. The SWEEP OUT voltage is set at 1 V.

- e. Connect a 10 k Ω (within 0.25%) resistor between the SWEEP OUT connector and ground with the probe attached to the SWEEP OUT connector.

- f. Set the Differential Comparator Comparison Voltage at 500 mV.

- g. CHECK that the 500 mV (within 5 mV) recenters the test oscilloscope trace. This corresponds to a 10 k Ω (within 2%) source resistance.

- h. Remove the resistor only from the SWEEP OUT connector.

8. Check SCAN MODE REPETITIVE Period

- a. Set the Sweep SCAN MODE switch at REPETITIVE and turn the VARIABLE OR EXT ATTEN control fully clockwise.

- b. Set the Differential Comparator Input Atten switch at 100 and the V_C Range switch at 0.

- c. Set the test oscilloscope Time Base switch at 10 ms and obtain a triggered display of the SWEEP OUT signal.

- d. CHECK that the repetitive period is 20 ms or less (see Fig. 5-3).

- e. Set the Time Base Time/Div switch at 1 s and decrease the trace intensity.

- f. Turn the VARIABLE OR EXT ATTEN control fully counterclockwise.

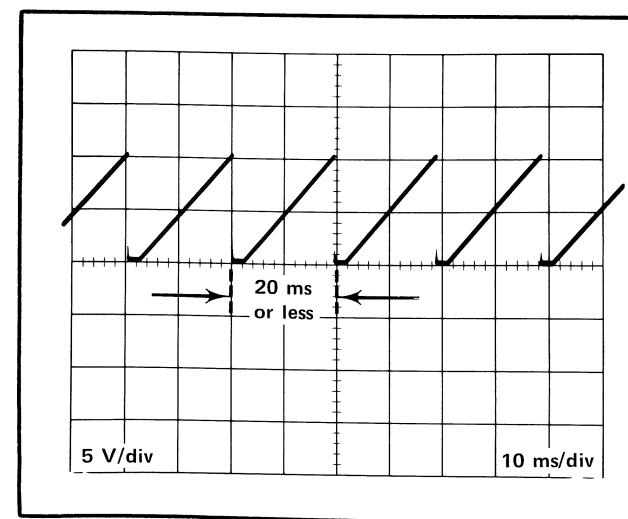

Fig. 5-3. Minimum sweep period check. The VARIABLE OR EXT ATTEN control is fully clockwise (Step 8 first part).

- g. CHECK that the repetitive period is 1 s or more.

- h. Remove the probe tip from the SWEEP OUT connector.

9. Check SCAN MODE MANUAL Operation

- a. Set the SCAN MODE switch at MANUAL.

- b. CHECK that the VARIABLE OR EXT ATTEN control moves the dot 10 div when it is rotated throughout its range (see Fig. 5-1).

10. Check SCAN MODE EXT Scan Deflection Factor

- a. Set the Sweep SCAN MODE switch at EXT and turn the VARIABLE OR EXT ATTEN control fully clockwise.

- b. Connect a meter test lead from the EXT IN jack to the +10 V Reference test point on the Sweep board and note the trace (dot) deflection. See A3 Sweep Callouts or Fig. 6-1 for the test point location.

- c. Set the Differential Comparator controls.

V_C Range	0
Comparison Voltage	10 V
A Input	DC
A Input Atten	1
Millivolts/Div	50
Display	A- V_C

- d. Connect the P6011 (1X) Probe tip to the TDR oscilloscope ground and center the test oscilloscope trace.

- e. Set the Differential Comparator V_C Range switch at +11 V.

- f. Connect the probe tip to the +10 V Reference test point and measure the exact voltage.

- g. Compute the deflection factor (volts/div) from the measurements.

- h. CHECK that the minimum deflection factor is 1 V/div (within 5%).

- i. Remove the probe from the test point. The test lead to the EXT IN jack remains attached.

11. Check SCAN MODE EXT IN Source Resistance

- Set the VARIABLE OR EXT ATTEN control fully clockwise for a 10 div deflection.
- Connect a 100 kΩ (within 1%) resistor between the EXT IN jack and the test lead to the +10 V Reference test point.
- Check that the dot deflection is within 4.44 div to 5.45 div. This corresponds to a source resistance of 100 kΩ (within 20%).
- Remove the test lead and resistor from the Sampler.

12. Check SAMPLING RATE Range

- Set the Sweep SCAN MODE switch to REPETITIVE.
- Set the test oscilloscope Time Base Time/Div switch at 10 μs, the Differential Comparator A Input Atten switch at 10 and the V_c Range switch at 0.
- Connect a P6011 (1X) Probe from the test oscilloscope A Input to the Sweep PULSE OUT connector. A BNC coaxial cable with a GR to BNC adapter may be used instead of the probe.
- Turn the SAMPLING RATE control fully clockwise and measure the pulse period (see Fig. 5-4).

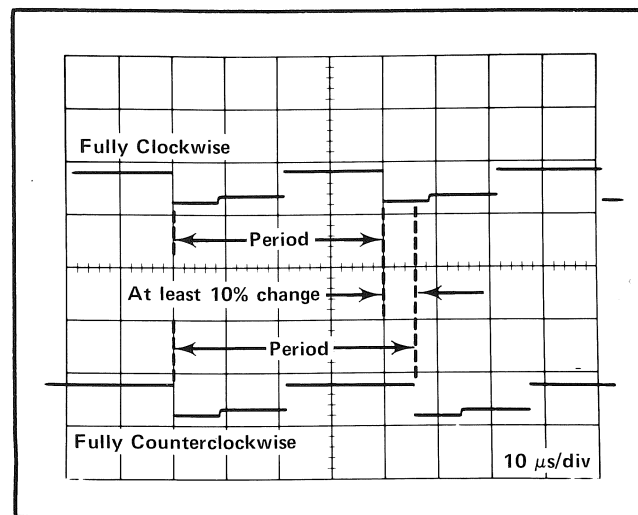

Fig. 5-4. Sampling Rate control range check (Step 12).

- CHECK that the period change (increase) is 10% or more when the SAMPLING RATE control is turned fully counterclockwise.

- Remove the probe or the coaxial cable with adapter from the connector.

13. Check System Reflection Risetime

- Connect a 20 inch coaxial cable from the Sweep PULSE OUT connector to the Sampler PULSE IN connector.
- Connect a 20 cm air line with a GR short termination attached to the Sampler TEST LINE connector.
- Set the Sampler UNITS switch at mρ and the UNITS/DIV switch at 200.
- Set the Sweep TIME/DIV switch at 100 ps and place the pulse trailing edge on the CRT. See Fig. 5-5.
- Adjust the Sampler ρ CAL control, if necessary, to obtain a 5 div pulse.
- Place the pulse top 2.5 div above the graticule center.
- CHECK the System Reflection Risetime from the 90% level to the 10% level of the pulse (4 div) for 140 ps or less.

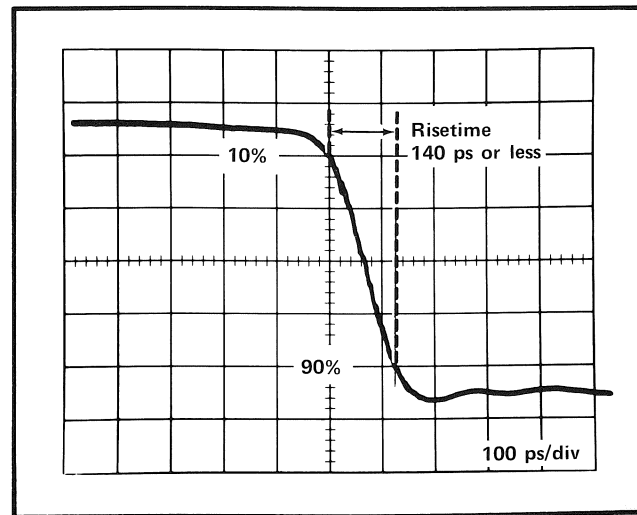

Fig. 5-5. Reflected pulse risetime measurement waveform (Step 13).

- Remove the air line with the GR short from the Sampler.

14. Check System Aberrations

- Install a GR 50-Ω termination on the TEST LINE connector.
- Set the Sweep TIME/DIV switch at 1 ns and adjust the TIME-DISTANCE control to position the pulse leading edge at graticule line 1.
- Set the Sampler UNITS/DIV control at 200 mρ and adjust the ρ CAL control for a 5 div step.
- Set the Sampler UNITS/DIV control at 20 mρ and adjust the DC OFFSET control to position the right end of the trace on the graticule center line (see Fig. 5-6).
- CHECK the first 4 ns (4 div) of the pulse top, starting at the pulse edge, that the aberrations do not exceed +4% (+2 div) or -6% (-3 div) and thereafter +2% (+1 div) or -2% (-1 div).

15. Check System Jitter

- Set the Sampler UNITS/DIV control at 200.
- Set the TIME-DISTANCE multiplier at X10 and the TIME/DIV switch at 2 ns.

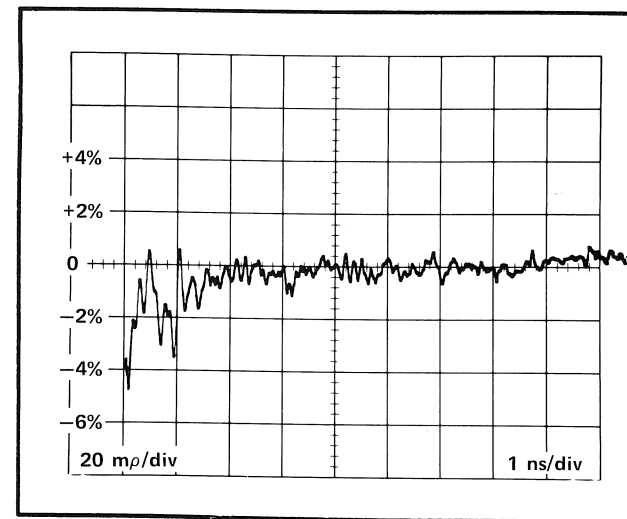

Fig. 5-6. System aberrations measurement (Step 14).

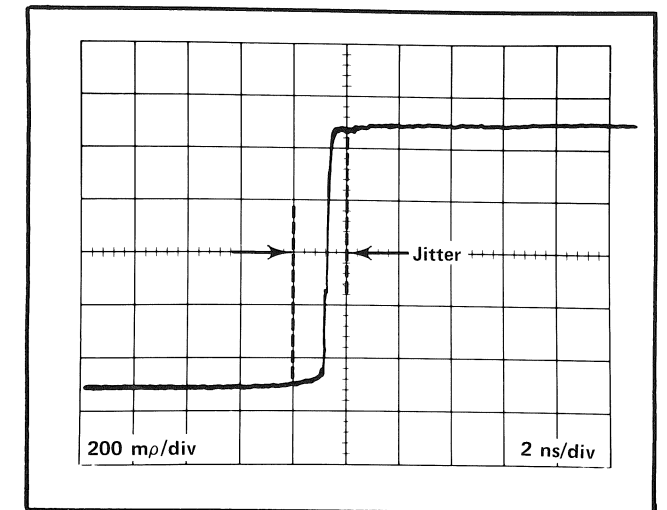

Fig. 5-7. System jitter measurement (Step 15, first part).

- Adjust the TIME-DISTANCE control to display the pulse edge and vertically center the step (see Fig. 5-7).
- CHECK that the pulse jitter does not exceed 2 ns (1 div).
- Set the TIME-DISTANCE MULTIPLIER at X1 and the TIME/DIV switch at 200 ps.
- Adjust the TIME-DISTANCE control to display the pulse edge.
- CHECK that the pulse jitter does not exceed 0.2 ns (1 div).
- Set the TIME-DISTANCE multiplier at X.1 and the TIME/DIV switch at 100 ps.
- Adjust the TIME-DISTANCE control to display the pulse edge.
- CHECK that the pulse jitter does not exceed 20 ps (0.2 div).

16. Check Deflection Factor Accuracy and Maximum Operating Input Signal

- Set the Sampler UNITS switch at mV.
- Disconnect the coaxial cable from the Sweep PULSE OUT connector and connect it to the 50 Ω Amplitude Calibrator Output connector.

c. Set the Calibrator DC-Square Wave switch at DC.

d. CHECK the Sampler UNITS/DIV switch positions for a 3% or less tolerance using the indicated Sampler and Calibrator switch positions. A measurement is made by placing the trace 3 div below graticule center and then switching the Calibrator Power OFF to obtain the positive trace shift. Turn the Power ON after each measurement.

Table 2

UNITS/DIV mV	50-Ω Amplitude Calibrator (V)	Trace Shift (Divisions)
200	.6	3 ±.09
100	.6	6 ±.18
50	.3	6 ±.18
20	.12	6 ±.18
10	.06	6 ±.18
5	.03	6 ±.18

17. Check UNITS/DIV VARIABLE Control Range

a. Connect the coaxial cable from the Sampler PULSE IN connector to the Sweep PULSE OUT connector.

b. Set the Sampler UNITS switch at mV and the UNITS/DIV switch at 200.

c. Set the Sweep TIME/DIV switch at 200 ns/div and adjust the TIME-DISTANCE control to display the 5 div step on the CRT.

d. Turn the UNITS/DIV VARIABLE control fully counterclockwise.

e. CHECK that the step amplitude is not more than 2 div. This corresponds to an attenuation ratio of at least 2.5:1.

f. Place the VARIABLE control at CAL.

18. Check Display Noise

a. Set the Sampler UNITS switch at mV and the UNITS/DIV switch at 500.

b. Connect the coaxial cable from the Sampler PULSE IN connector to the 50 Ω Amplitude Calibrator Output connector.

c. Set the 50 Ω Amplitude Calibrator at .6 VDC and turn its Power OFF.

d. Center the trace and then turn the Calibrator Power ON.

e. Adjust the Sampler UNITS/DIV VARIABLE control (and ρ CAL control, if necessary) to place the trace 3 div below the graticule center. The Sampler is now calibrated for 200 mV/div.

f. Set the UNITS/DIV switch at 5. Do not disturb the VARIABLE control.

g. Remove the coaxial cable from the 50 Ω Amplitude Calibrator.

h. Adjust the Sweep DC OFFSET control to display the trace.

i. CHECK that the noise (90% of the trace width) is not greater than 1 mV (0.5 div). See Fig. 5-8.

j. Set the VARIABLE control at CAL.

19. Check DC OFFSET Control Range

a. Set the Sampler UNITS switch at mV and the UNITS/DIV switch at 500.

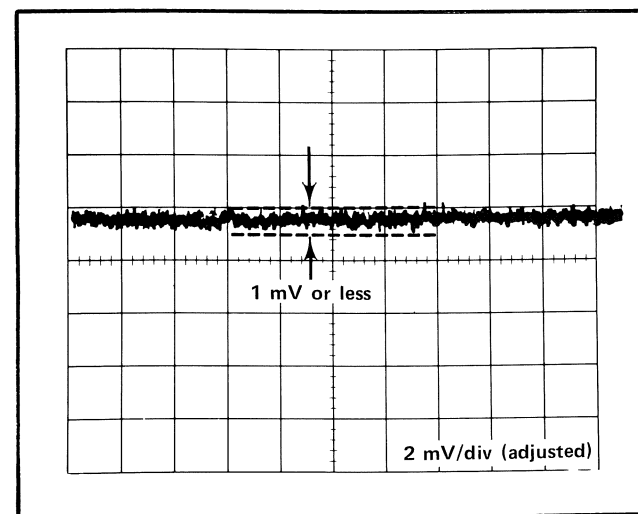

Fig. 5-8. Display noise check (Step 18).

b. Turn the DC OFFSET and FINE controls fully clockwise.

c. CHECK that the trace is at least +1 V (2 div) above the graticule center.

d. Turn the DC OFFSET and FINE controls fully counterclockwise.

e. CHECK that the trace is at least -1 V (2 div) below the graticule center.

20. Check VERT SIG OUT Accuracy

a. Set the Sampler UNITS/DIV switch at 200 mV and place the trace at graticule center.

b. Set the Type 3A7 Differential Comparator controls.

V _C Range	0
Comparison Voltage	600 mV
Millivolts/Div	50
A Input	DC
A Input Atten	1
Display	A-V _C

c. Set the Type 2B67 Time Base controls.

Time/Div	10 ms
Mode	Norm
Triggering	
Level	Auto
Slope	+
Coupling	AC Slow
Source	Int

d. From the Differential Comparator A Input connect the P6011 (1X) Probe tip to the VERT SIG OUT connector.

e. Place the base of the test oscilloscope waveform at graticule center.

f. Set the Sampler trace 3 div below the graticule center.

g. Set the Differential Comparator V_C Range switch at -1.1.

h. CHECK that the Comparison Voltage of 600 mV (within 30 mV) recenters the trace. This corresponds to the VERT SIG OUT signal of 200 mV/div (within 5%) of display (or trace shift).

21. Check VERT SIG OUT Source Resistance

a. Set the Type 3A7 Differential Comparator controls.

V _C Range	0
Comparison Voltage	1 V
A Input	DC
A Input Atten	1
Millivolts/Div	50
Display	A-V _C

b. Set the Time Base Time/Div switch at 1 ms.

c. Set the TDR Sampler UNITS/DIV switch at 100 mV.

d. Ground the P6011 (1X) Probe tip to the Sampler ground and position the free running test oscilloscope trace at graticule center.

e. Connect the probe tip to the Sampler VERT SIG OUT connector.

f. Set the Differential Comparator V_C Range switch at +1.1.

g. Adjust the Sampler DC OFFSET control to position the test oscilloscope trace base line (ignore the signal information) at the graticule center.

h. Set the Differential Comparator Comparison Voltage at 500 mV.

i. Connect a 10 kΩ (.25%) resistor between the VERT SIG OUT connector and ground. The probe tip is attached to the connector.

j. CHECK that a comparison voltage of 500 mV (within 5 mV) recenters the test oscilloscope trace. This corresponds to a 10 kΩ (within 2%) source resistance.

This completes the Performance Check Procedure.

NOTES

SECTION 6 CALIBRATION

Change information, if any, affecting this section will be found at the rear of this manual.

Introduction

The 3S7 TDR Sampler and the 3T7 TDR Sweep should be recalibrated every six months or 1000 hours (whichever comes first) and after any repair that affects the calibration of the instrument.

The Calibration procedure contains the adjustment steps necessary to calibrate the 3S7 TDR Sampler and the 3T7 TDR Sweep. The procedure should be followed by the Performance Check procedure. The 3S7 TDR Sampler and the 3T7 TDR Sweep front panel controls are indicated by UPPER CASE LETTERS in the following procedure.

RECOMMENDED EQUIPMENT

The following equipment, or its equivalent, is required for complete calibration of the Time Domain Reflectometer. Equipment specifications given are the minimum necessary for accurate calibration of the instruments. All test equipment is assumed to be correctly calibrated and operating within the original specifications. If equipment is substituted, it must meet or exceed the specifications of the recommended equipment.

Test Equipment

1. Indicator Oscilloscope. Type 561B or other oscilloscope in which the Time Domain Reflectometer may be used.

2. Test Oscilloscope. Type 560-series with a Type 3A7 Differential Comparator and a Type 2B67 Time Base. The minimum vertical deflection factor requirement is 10 mV/div. The maximum sweep rate requirement is 10 μ s/div. A Type 547 Oscilloscope with a Type W Differential Comparator may be used.

3. Time Mark Generator, Tektronix 2901. The marker requirements are 1 μ s, with sub-multiples through 2 ns (within 0.3%). The trigger output requirement is 10 μ s period triggers.

4. Calibrator. 50 Ω Amplitude Calibrator, Tektronix Calibration Fixture 067-0508-00. The signal amplitude

requirements are 30 mV and multiples through 600 mV (within 0.25%).

5. Air line. GR 20-cm length, 50 Ω impedance. Tektronix Part No. 017-0084-00.

6. Cable. 20-inch Coaxial Cable Assembly with GR connectors. Tektronix Part No. 017-0515-00.

7. Cable. Plug-In Unit Extender Cable. Tektronix Part No. 012-0064-00.

8. Cable. 50- Ω coaxial cable at least 3 feet long with BNC connectors. Tektronix Part No. 012-0057-01.

9. Probe. 10X attenuation, P6012. Tektronix Part No. 010-0202-00.

10. Adapter. GR to BNC female connector. Tektronix Part No. 017-0063-00.

11. Adapter. GR to BNC male connector. Tektronix Part No. 017-0064-00.

12. Termination. GR short-circuit, Tektronix Part No. 017-0087-00.

13. Termination. GR 50- Ω end-line. Tektronix Part No. 017-0081-00.

CALIBRATION PROCEDURE

General

In the following procedure, test equipment connections or control settings should not be changed except as noted.

Preliminary Procedure

a. Install the 3S7 TDR Sampler in the Vertical (left) compartment of the Indicator Oscilloscope.

b. Install the 3T7 TDR Sweep in the Horizontal (right) compartment of the Indicator Oscilloscope, and remove the right side panel of the oscilloscope to gain access to the internal controls of the Sweep.

c. Install a GR 50 Ω termination on the 3S7 TDR Sampler TEST LINE connector. The pulse cable to the Sampler is not connected at this time.

d. Turn the power ON to the Time Mark Generator, the 50 Ω Amplitude Calibrator, the Indicator and test oscilloscopes, and allow a 5-minute warmup.

e. Set the 3T7 TDR Sweep controls as follows:

PRESET	right position
TIME/DIV	1 μ s/div
TIME-DISTANCE	0
FINE	fully CW
SCAN MODE	REPETITIVE
VARIABLE OR EXT ATTEN	fully CW

f. Set the 3S7 TDR Sampler controls as follows:

UNITS	mV
UNITS/DIV	100
RESOLUTION	NORMAL
POLARITY	+UP
DC OFFSET	center the trace

3T7 TDR SWEEP CALIBRATION

1. Adjust Scan Rate Control (R206)

a. Set the Type 3A7 Differential Comparator controls as follows:

V _c Range	0
A Input	DC
A Input Atten	10
Millivolts/Div	50
Display	A-V _c

b. Set the test oscilloscope Time/Div switch at 1 s/div after placing its Intensity control at a low level position.

c. Connect a P6012 (10X) Probe from the test oscilloscope A Input to the 3T7 TDR Sweep test point TP210. TP210 is located between Plug 2 (red) and Plug 3 (orange) at the upper right edge of the circuit board. See Fig. 6-1 for TP210 location.

d. Turn the VARIABLE OR EXT ATTEN control fully counterclockwise.

e. Adjust R206 for a scan ramp of 1 s or more (1 div or more) as measured by the test oscilloscope. See Fig. 6-1 for R206 location and Fig. 6-2 for the waveform.

f. Remove the probe tip from the test point.

2. Adjust SWEEP CAL and HORIZ POS Controls

a. Set the 3T7 TDR Sweep SCAN MODE switch at MANUAL after placing the TDR oscilloscope Intensity control at a low level position.

b. Adjust the SWEEP CAL and the HORIZ POS controls (front panel screwdriver adjust) so the dot moves from graticule line zero to graticule line ten as the VARIABLE OR EXT ATTEN control is turned from the fully counterclockwise position to the fully clockwise position. The SWEEP CAL control sets the distance the dot moves, and the HORIZ POS control positions the dot range of movement on the CRT face. The two controls interact. See Fig. 6-3.

c. Set the 3T7 TDR Sweep SCAN MODE switch at REPETITIVE.

d. Turn the VARIABLE OR EXT ATTEN control fully clockwise.

3. Adjust Sampling Rate Control (R412)

a. Turn the 3S7 TDR Sampler front panel SAMPLING RATE control (screwdriver adjust) fully clockwise.

b. Adjust R412 while the LOCATE button is fully depressed. R412 is correctly adjusted when the ramp at the right end of the trace is only slightly apparent outside the right edge of the graticule (see Fig. 6-4 for this waveform). The trace intensity must be sufficient to show the right end of the trace when the LOCATE button is pushed. See Fig. 6-1 for R412 location.

4. Adjust Timing Controls (R532 and C525)

a. Connect a P6012 (10X) Probe BNC connector end to the 2901 Time Mark Generator Trigger Out connector and the probe tip to test point TP407. See Fig. 6-1 for TP407, R532 and C525 locations.

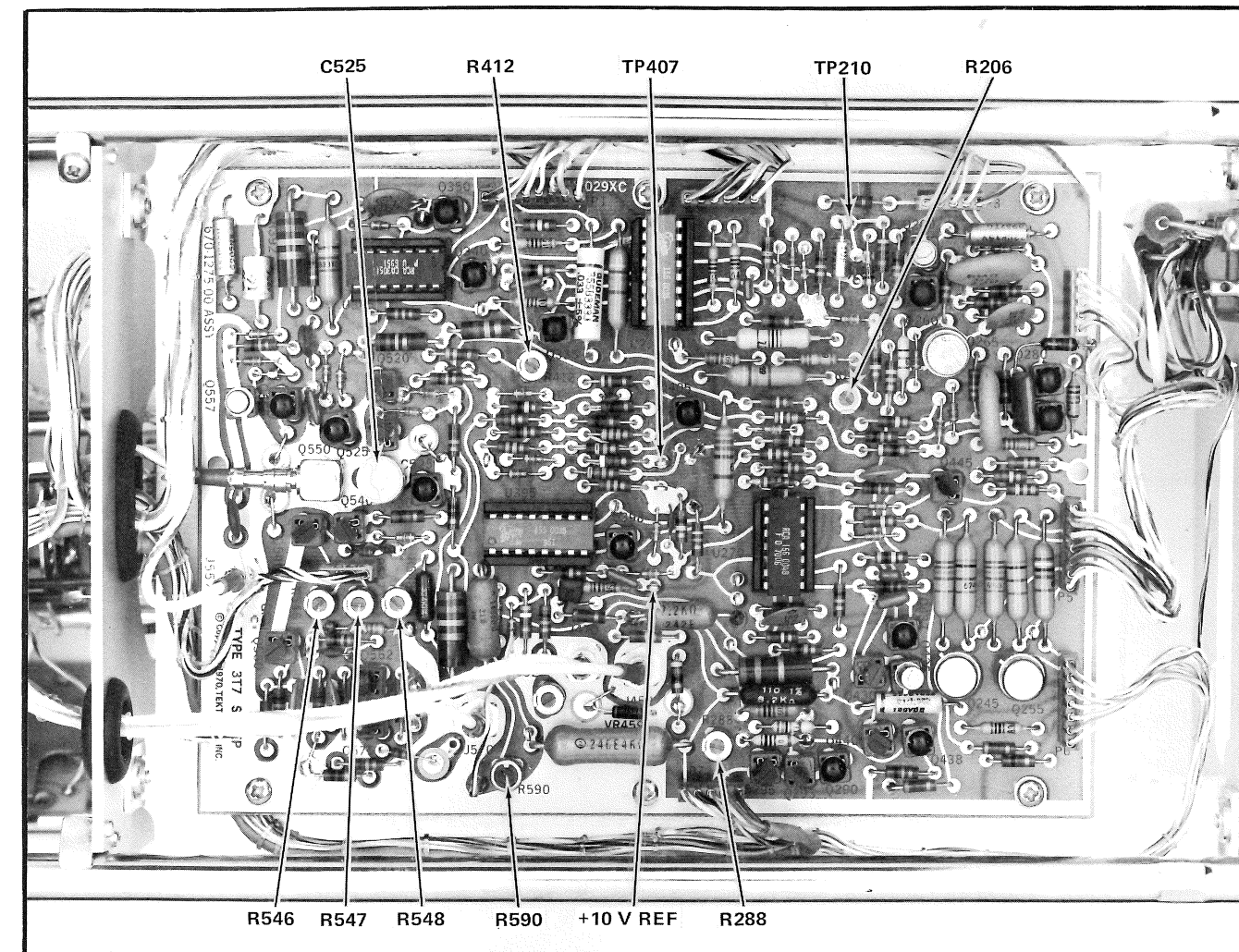

Fig. 6-1. 3T7 TDR Sweep calibration test points and controls locations.

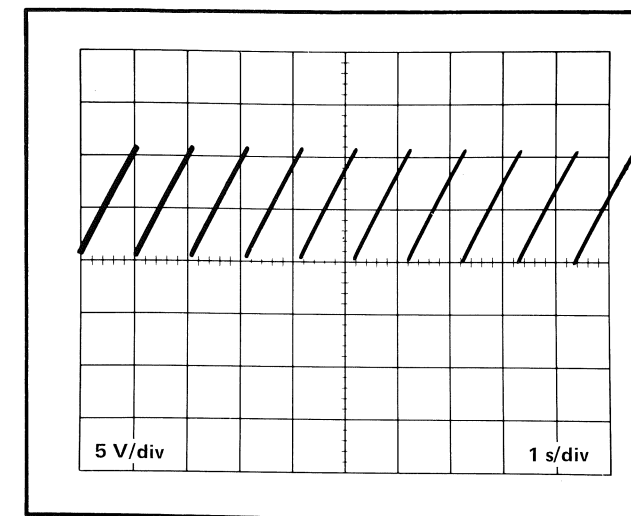

Fig. 6-2. Waveform showing the Scan Rate control (R206) adjustment (Step 1). Each ramp has a period of 1 second or more and represents one scan of the TDR oscilloscope trace.

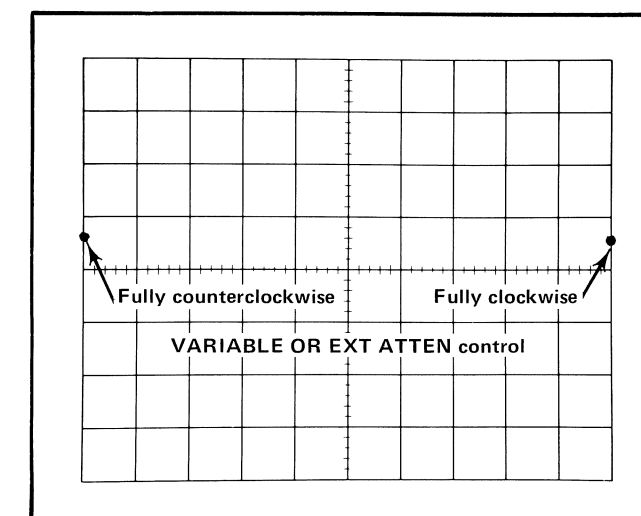

Fig. 6-3. The correct dot range of movement for MANUAL SCAN operation (Step 2).

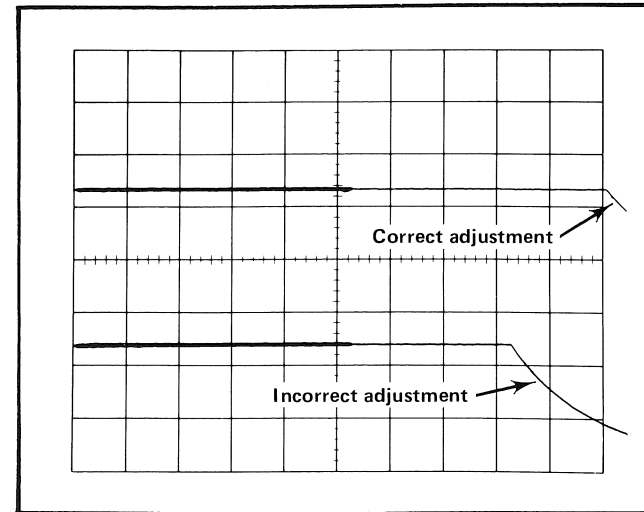

Fig. 6-4. Waveform showing correct and incorrect R412 control adjustment (Step 3).

b. Connect a BNC coaxial cable with a GR to BNC female adapter from the 2901 Time Mark Generator Marker Out connector to the 3S7 TDR Sampler PULSE IN connector.

c. Set the 3T7 TDR Sweep TIME/DIV switch at 1 $\mu\text{s}/\text{div}$.

d. Set the 2901 Time Mark Generator Marker Selector at 1 μs and the Trigger Selector at 10 μs .

e. Set the 3S7 TDR Sampler controls as follows:

UNITS	mV
UNITS/DIV	200
RESOLUTION	NORMAL
POLARITY	+UP
DC OFFSET	display waveform

f. Adjust R532 to obtain 1 pulse per CRT graticule vertical line using graticule lines 1 through 9 (see Fig. 6-5). Adjust the TIME-DISTANCE control as necessary to position the markers on the graticule lines. The SAMPLING RATE control may be adjusted if necessary to stabilize the waveform.

g. Set the 3T7 TDR Sweep TIME/DIV switch to 10 ns/div.

h. Set the 2901 Time Mark Generator Marker Selector at 10 ns.

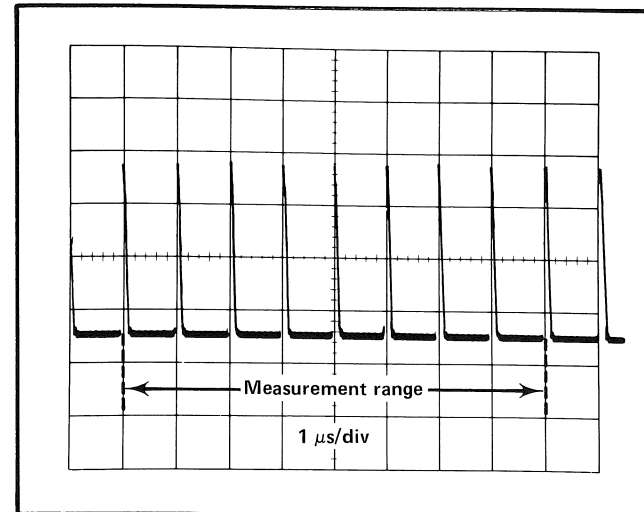

Fig. 6-5. Waveform showing correct R532 control adjustment (Step 4).

i. Adjust C525 for 1 cycle/div (see Fig. 6-6).

5. Adjust TIME-DISTANCE Calibration Control (R288)

a. Set the 2901 Time Mark Generator Marker Selector at 1 μs .

b. Set the 3T7 TDR Sweep TIME/DIV control at 100 ns/div.

c. Set the 3T7 TDR Sweep TIME-DISTANCE scale at zero.

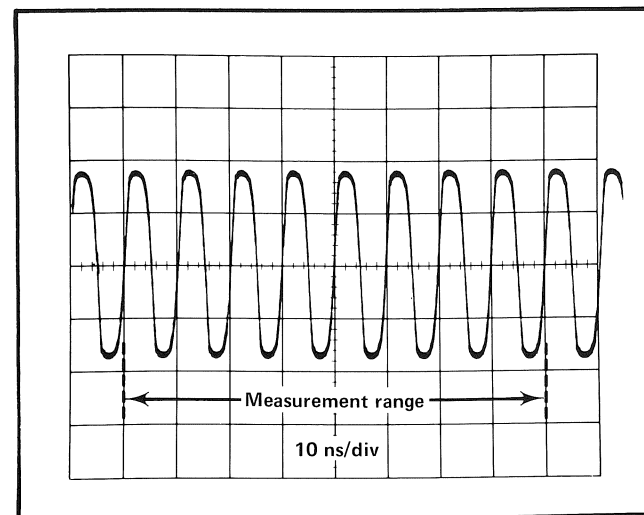

Fig. 6-6. Waveform showing correct C525 control adjustment (Step 4).

d. Set the 3T7 TDR Sweep FINE control to place the pulse at graticule line eight (see Fig. 6-7).

e. Set the TIME-DISTANCE scale at 1.00 μs .

f. Adjust R288 to position the next 1 μs pulse at graticule line eight. See Fig. 6-1 for R288 location.

g. Remove the probe and the coaxial cable with adapter from the 3S7 TDR Sweep and the 3T7 TDR Sampler.

6. Adjust Pulse Zero Set Controls (R546, R547 and R548)

a. Connect a 20-inch coaxial cable from the 3T7 TDR Sweep PULSE OUT connector to the 3S7 TDR Sampler PULSE IN connector.

b. Set the 3T7 TDR Sweep TIME/DIV switch at 1 $\mu\text{s}/\text{div}$.

c. Set the 3T7 TDR Sweep TIME-DISTANCE scale at zero and the FINE control fully clockwise.

d. Set the 3S7 TDR Sampler UNITS/DIV switch at 50 mV/div.

e. Adjust R546 to position the pulse step 0.5 div from the graticule left edge. See Fig. 6-1 for R546, R547 and R548 locations and Fig. 6-8 for correct pulse position.

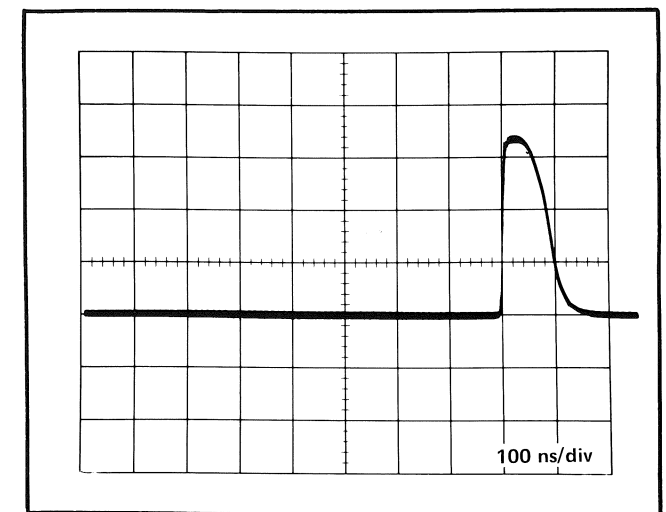

Fig. 6-7. Waveform showing the correct pulse position for adjusting the TIME-DISTANCE calibration R288 control (Step 5).

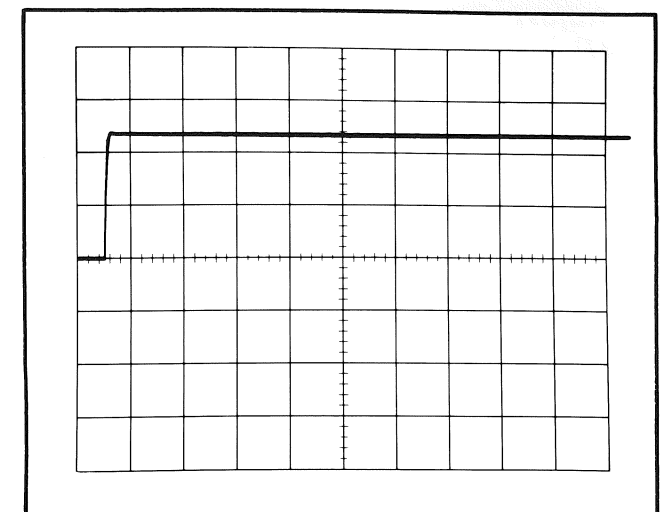

Fig. 6-8. Waveform showing correct adjustments of R546, R547 and R548 (Step 6) and R590 (Step 7).

f. Set the 3T7 TDR Sweep TIME/DIV switch at 100 ns/div.

g. Adjust R547 to position the pulse step 0.5 div from the graticule left edge (see Fig. 6-8).

h. Set the 3T7 TDR Sweep TIME/DIV switch at 10 ns/div.

i. Adjust R548 to position the pulse step 0.5 div from the left graticule edge. If the Sweep is calibrated when using an extender cable between the 3T7 TDR Sampler and the TDR oscilloscope, set the pulse step (vertical portion) as near as possible to the left graticule edge.

7. Adjust Pulser Bias Level Control (R590)

a. Disconnect the coaxial cable from the 3S7 TDR Sampler PULSE IN connector.

b. Set the 3T7 TDR Sweep TIME/DIV switch at 1 μs .

c. Adjust the 3S7 TDR Sweep DC OFFSET control to place the TDR trace at the vertical center of the TDR graticule.

d. Reconnect the coaxial cable to the 3S7 TDR Sampler PULSE IN connector.

e. Adjust R590 to position the bottom of the pulse at the vertical center of the TDR graticule (see Fig. 6-8). See Fig. 6-1 for R590 location.

8. Adjust Pulser Trigger Amplitude Control (C587)

C587 is the capacitor that is formed by the proximity of the body of R586 and the tip of the J580 coaxial connector center conductor (see Fig. 6-9). The connector is threaded into the Pulser shield and locked by a 1/4-inch nut. The capacitor is adjusted by turning the connector to position the tip near the resistor. C587 is set at the factory and normally is not adjusted during recalibration. After Pulser repair and reassembly, C587 should be readjusted.

a. Turn the power OFF, disconnect the coaxial cable from the 3T7 TDR Sweep PULSE OUT connector, and remove the 3T7 TDR Sweep from the TDR oscilloscope.

b. Connect a Plug-in Unit Extender cable (Tektronix Part No. 012-0066-00) to the 3T7 TDR Sweep rear connector, and to the TDR oscilloscope Horizontal compartment input connector. Turn the power ON.

c. Reconnect the coaxial cable to the 3T7 TDR Sweep PULSE OUT connector.

d. Install a 20 cm air line (unterminated) on the 3S7 TDR Sweep TEST LINE connector.

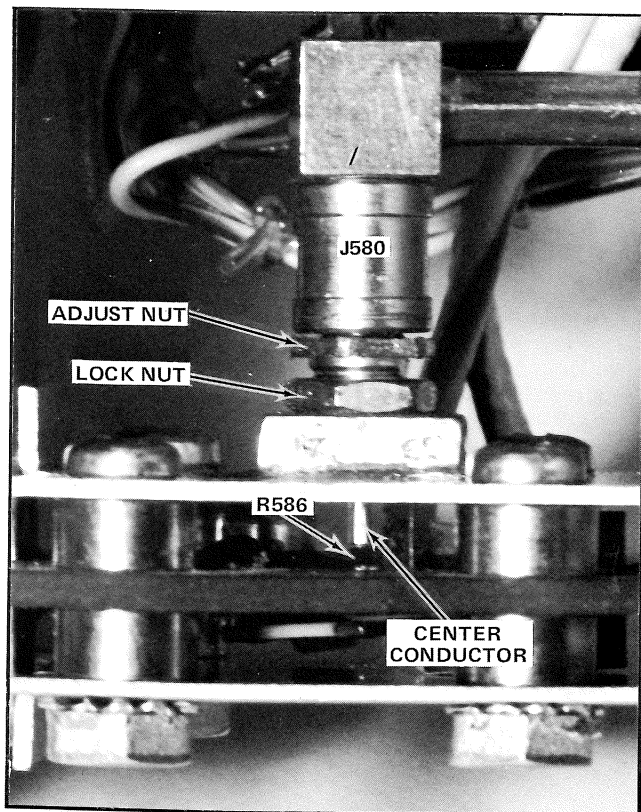

Fig. 6-9. Pulser assembly components which compose C587.

e. Set the 3T7 TDR Sweep TIME/DIV Magnifier switch at X1 and the TIME/DIV switch at 1 ns.

f. Set the 3S7 TDR Sampler UNITS/DIV switch at 100 mV.

g. Loosen the lock nut on the connector with a 1/4 inch wrench.

h. Carefully turn the 1/4 inch connector adjust nut with the wrench clockwise until the pulse step is distorted when the tip of the center conductor touches the resistor body but do not force (see Fig. 6-10 top waveform) and then slightly back off to obtain an undistorted waveform (see Fig. 6-10 middle waveform). This waveform is the result of the incident pulse and the reflected pulse. The pulse is lost when the adjustment is backed off too much (see Fig. 6-10 bottom waveform). The lock nut should be partially tightened during this adjustment.

i. Tighten the lock nut and check that the desired pulse waveform is not changed.

j. Turn the power OFF, remove the extender cable from between the 3T7 TDR Sweep and the oscilloscope, and disconnect the coaxial cable at the PULSE OUT connector.

k. Install the 3T7 TDR Sweep in the oscilloscope and reconnect the coaxial cable to the PULSE OUT connector.

l. Install a 50 Ω termination in place of the air line.

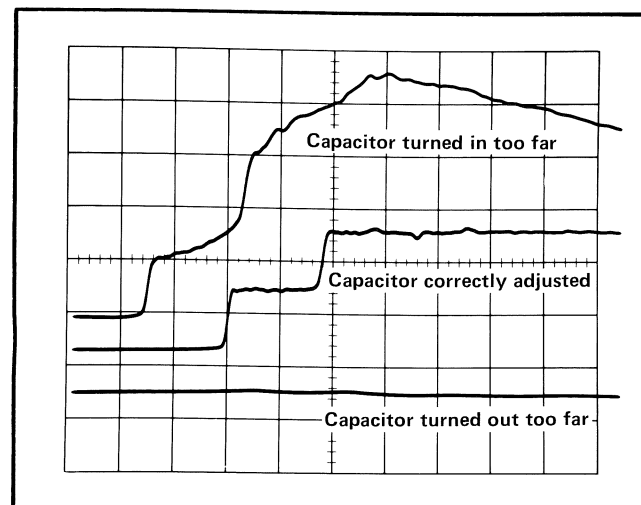

Fig. 6-10. Pulser waveforms showing the effects of C587 adjustment (Step 8).

3S7 TDR SAMPLER CALIBRATION

9. Adjust Avalanche Control (R78)

a. Disconnect the coaxial cable from the 3S7 TDR Sampler PULSE IN connector and remove the Sampler from the TDR oscilloscope.

b. Connect a Plug-In Unit Extender cable to the Sampler rear connector and to the TDR oscilloscope Vertical compartment input connector, and turn the power ON.

c. Reconnect the coaxial cable to the 3S7 TDR Sampler PULSE IN connector.

d. Set the test oscilloscope Differential Comparator controls.

V _C Range	0
A Input	AC
A Input Atten	100
Millivolts/Div	10
Display	A-V _C

e. Set the test oscilloscope Time Base Time/Div switch at 50 μs/div.

f. Connect a P6012 (10X) Probe to the Differential Comparator A Input.

g. Touch the probe tip to Q75 base (center pin). See Fig. 6-11 for Q75 location. Q75 is mounted on the back side of the circuit board.

h. Adjust control R78 for a waveform with 58 V spikes. See Fig. 6-12 for the waveform.

10. Adjust Snap-off Control (R81)

a. Connect the 20-cm air line with a GR short attached to the Sampler TEST LINE connector.

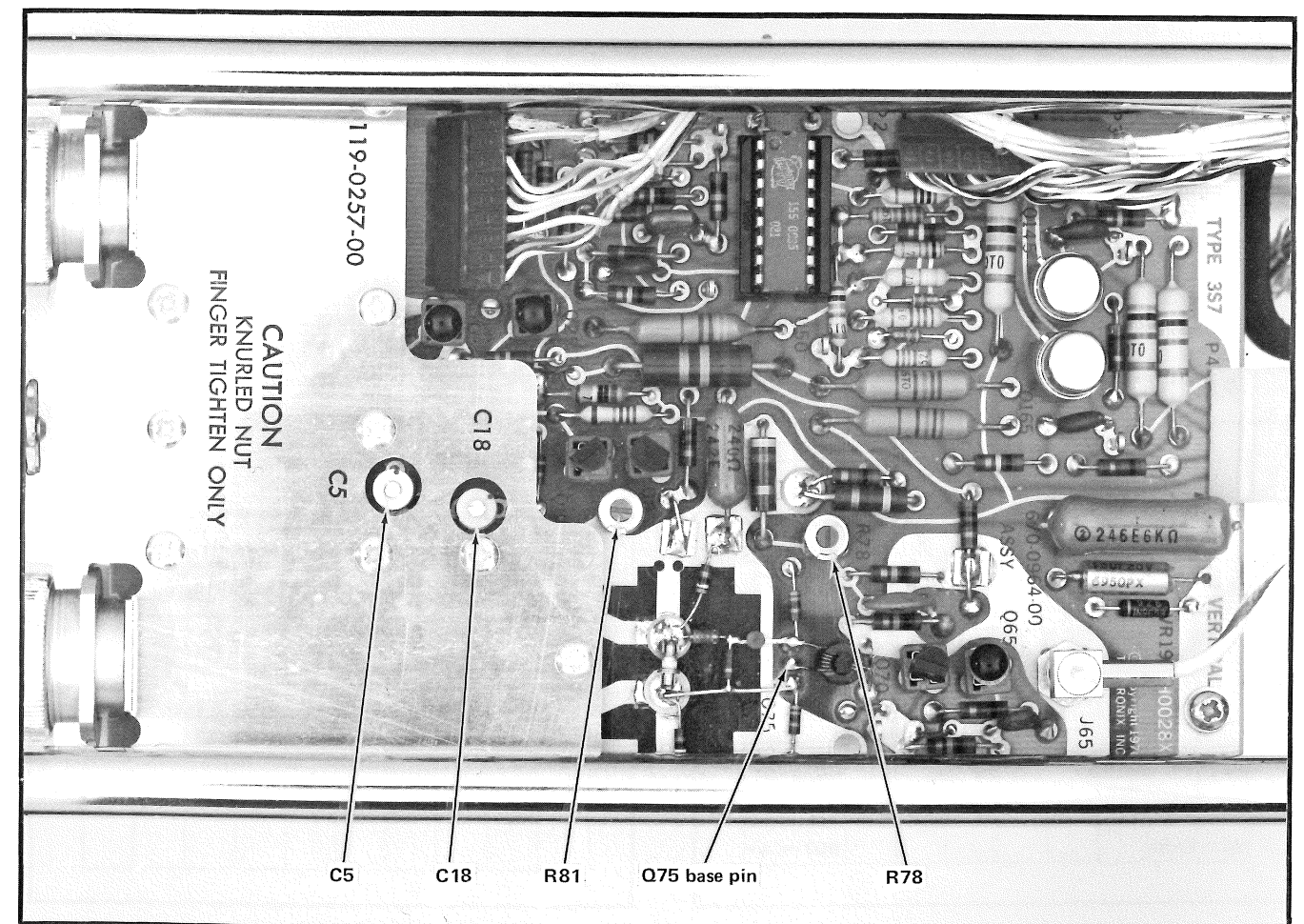

Fig. 6-11. 3S7 TDR Sampler calibration controls locations.

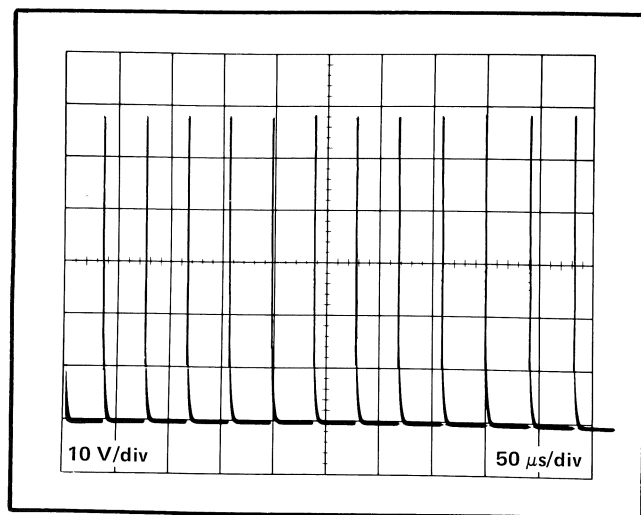

Fig. 6-12. Waveform at Q75 base showing properly adjusted Avalanche control (R78) for Step 9.

b. Set the Sweep TIME-DISTANCE Multiplier switch at X1 and the TIME/DIV switch at 500 ps.

c. Set the Sampler UNITS/DIV switch at 20 mV.

d. Display the pulse on the CRT.

e. Adjust R81 to obtain corners that are as square as possible at the bottom front and top rear corners of the pulse. See Fig. 6-13, which shows a typical, properly adjusted pulse waveform. The control position should be near the clockwise end of rotation.

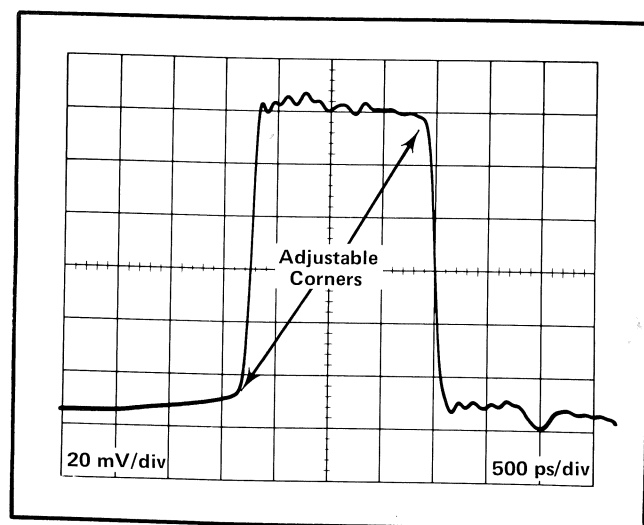

Fig. 6-13. Pulse waveform showing proper adjustment of the Snap-off control R81 (Step 10).

11. Adjust Blow-by Control (C5) and Loop Gain Control (C18)

a. Connect a 50 Ω termination on the Sampler TEST LINE connector in place of the air line and GR short.

b. Position the step on the CRT.

c. Decrease the loop gain by adjusting C18. At low loop gain, the beginning of the trace is raised above its normal level. See Fig. 6-14.

d. Set the Sampler UNITS/DIV switch at 5 and position the top of the step on the CRT.

e. Minimize the trace width (horizontal portion) by adjusting the Blow-by control C5.

f. Set the Sampler UNITS/DIV switch at 20 and display the step on the CRT.

g. Adjust the Loop Gain control C18 to remove the rise at the beginning of the trace. Excessive loop gain causes oscillation and loss of step waveform.

h. Set the TDR oscilloscope Calibrator at .2 V (into 50 Ω).

i. Remove the coaxial cable from the Sweep PULSE OUT connector and connect the cable to the TDR oscillo-

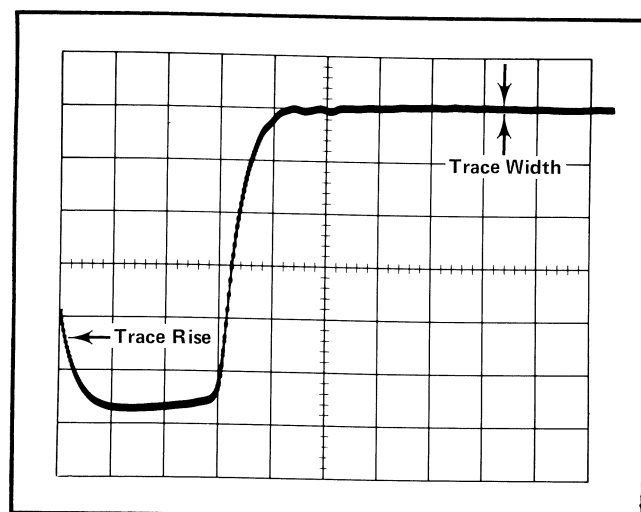

Fig. 6-14. Waveform shows trace rise due to low loop gain adjustment of C18. Excessive trace width is due to incorrect setting of C5 (Step 11).

scope CAL OUT connector by using a GR to BNC (male) adapter.

j. Set the Sampler UNITS/DIV switch at 50 mV/div.

k. Complete the adjustment of C18 by setting it to obtain a flat-top square wave (free-running). See Fig. 6-15, which shows the correct waveform.

12. Adjust Vertical GAIN Control

a. Connect the coaxial cable from the Sampler PULSE IN connector to the 50 Ω Amplitude Calibrator (Tektronix Part No. 067-0508-00) Output connector.

b. Set the Calibrator Volts switch at .3 and the DC-Square Wave switch at DC.

c. Set the Sampler UNITS/DIV switch at 50.

d. Place the trace 3 div below graticule center.

e. Switch to 50 Ω Amplitude Calibrator Power OFF.

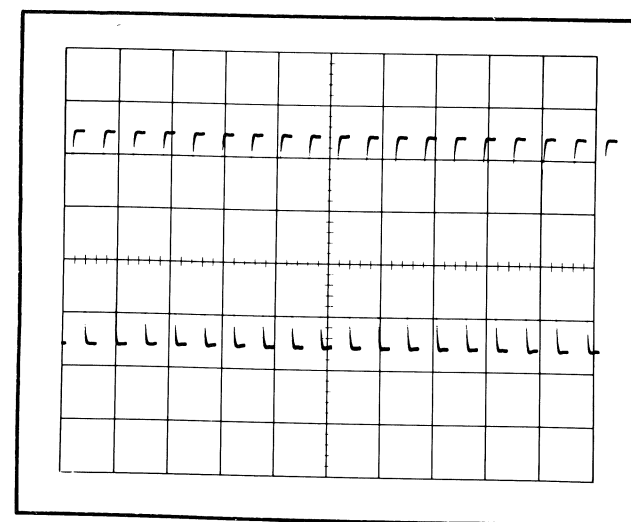

Fig. 6-15. Correct squarewave waveform resulting from correctly adjusted C18 (Step 11, last part).

f. Adjust the Vertical GAIN control (front panel screwdriver adjust) for a .3 V (6 div) positive vertical trace shift.

g. Check the previous adjustment by switching the 50 Ω Amplitude Calibrator Power ON and repeating the procedure starting at part d until no adjustment of the GAIN control is necessary.

13. Adjust Rho CAL Control

a. Connect the coaxial cable from the Sampler PULSE IN connector to the Sweep PULSE OUT connector.

b. Set the Sampler UNITS switch to mρ and the UNITS/DIV switch at 200.

c. Set the Sweep TIME/DIV switch at 20 ns.

d. Adjust the ρ CAL control (screwdriver adjust) for a five division step amplitude. See Fig. 6-16 for this waveform.

This completes the Calibration Procedure.

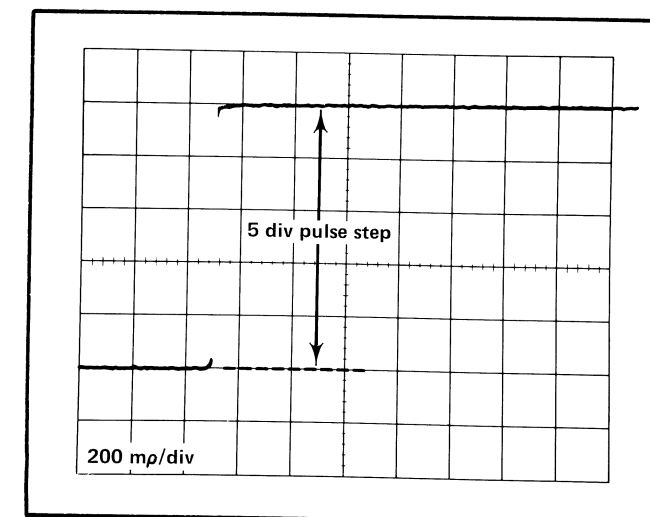

Fig. 6-16. Waveform showing the correct step amplitude for the ρCAL control adjustment (Step 13).

NOTES

PARTS LIST ABBREVIATIONS

BHB	binding head brass	int	internal
BHS	binding head steel	lg	length or long
cap.	capacitor	met.	metal
cer	ceramic	mtg hdw	mounting hardware
comp	composition	OD	outside diameter
conn	connector	OHB	oval head brass
CRT	cathode-ray tube	OHS	oval head steel
csk	countersunk	P/O	part of
DE	double end	PHB	pan head brass
dia	diameter	PHS	pan head steel
div	division	plstc	plastic
elect.	electrolytic	PMC	paper, metal cased
EMC	electrolytic, metal cased	poly	polystyrene
EMT	electrolytic, metal tubular	prec	precision
ext	external	PT	paper, tubular
F & I	focus and intensity	PTM	paper or plastic, tubular, molded
FHB	flat head brass	RHB	round head brass
FHS	flat head steel	RHS	round head steel
Fil HB	fillister head brass	SE	single end
Fil HS	fillister head steel	SN or S/N	serial number
h	height or high	S or SW	switch
hex.	hexagonal	TC	temperature compensated
HHB	hex head brass	THB	truss head brass
HHS	hex head steel	thk	thick
HSB	hex socket brass	THS	truss head steel
HSS	hex socket steel	tub.	tubular
ID	inside diameter	var	variable
inc	incandescent	w	wide or width
		WW	wire-wound

PARTS ORDERING INFORMATION

Replacement parts are available from or through your local Tektronix, Inc. Field Office or representative.

Changes to Tektronix instruments are sometimes made to accommodate improved components as they become available, and to give you the benefit of the latest circuit improvements developed in our engineering department. It is therefore important, when ordering parts, to include the following information in your order: Part number, instrument type or number, serial or model number, and modification number if applicable.

If a part you have ordered has been replaced with a new or improved part, your local Tektronix, Inc. Field Office or representative will contact you concerning any change in part number.

SPECIAL NOTES AND SYMBOLS

- ×000 Part first added at this serial number
 00× Part removed after this serial number
 *000-0000-00 Asterisk preceding Tektronix Part Number indicates manufactured by or for Tektronix, Inc., or reworked or checked components.
 Use 000-0000-00 Part number indicated is direct replacement.

INDEX OF ELECTRICAL PARTS LIST

Title	Page No.
CHASSIS (357)	7-1
A1 357 VERTICAL Circuit Board Assembly	7-2
A2 357 POSITION INDICATOR Circuit Board Assembly	7-6
CHASSIS (3T7)	7-7
A3 3T7 SWEEP Circuit Board Assembly	7-8
A4 3T7 PULSER Circuit Board Assembly	7-14

SECTION 7 ELECTRICAL PARTS LIST

3S7

Values are fixed unless marked Variable.

CHASSIS

Ckt. No.	Tektronix Part No.	Serial/Model No. Eff	No. Disc	Description		
Capacitors						
Tolerance $\pm 20\%$ unless otherwise indicated.						
C30	283-0177-00			1 μF	Cer	25 V
C179	290-0215-00			100 μF	Elect.	25 V
Bulbs						
DS40	150-0035-00			Neon, A1D T2		
DS155	150-0035-00			Neon, A1D T2		
DS175	150-0035-00			Neon, A1D T2		
Connectors						
J1	*132-0139-00			Receptacle, electrical, assembly		
J2	*132-0139-00			Receptacle, electrical, assembly		
J139	136-0140-00			Socket, Banana Jack		
P11	131-0149-00			24 contact, male		
Resistors						
Resistors are fixed, composition, $\pm 10\%$ unless otherwise indicated.						
R30 } R31 }	311-0679-00			2 x 10 k Ω , Var		
R40	311-0398-00			5 k Ω , Var		
R41	321-0222-00			2 k Ω	$\frac{1}{8}$ W	Prec
R42	321-0251-00			4.02 k Ω	$\frac{1}{8}$ W	Prec
R43	321-0280-00			8.06 k Ω	$\frac{1}{8}$ W	Prec
R44	321-0318-00			20 k Ω	$\frac{1}{8}$ W	Prec
R45	321-0347-00			40.2 k Ω	$\frac{1}{8}$ W	Prec
R46	321-0376-00			80.6 k Ω	$\frac{1}{8}$ W	Prec
R47	321-0414-00			200 k Ω	$\frac{1}{8}$ W	Prec
R48	315-0104-00			100 k Ω	$\frac{1}{4}$ W	5%
R124	311-1043-00			2 k Ω , Var		
R172	311-0629-00			3 k Ω , Var		
R179	308-0078-00			70 Ω	5 W	WW
R190	301-0473-00			47 k Ω	$\frac{1}{2}$ W	5%

CHASSIS (cont)

Ckt. No.	Tektronix Part No.	Serial/Model No. Eff	No. Disc	Description
Switches				
Wired or Unwired				
S40	Wired *262-0912-00			Rotary UNITS/DIV
S40	260-1192-00			Rotary UNITS/DIV
S120	260-0969-00			Slide RESOLUTION
S124	260-0449-00			Slide
S140	260-0447-00			Slide POLARITY

A1 357 VERTICAL Circuit Board Assembly

*670-0964-00

Complete Board

Capacitors

Tolerance $\pm 20\%$ unless otherwise indicated.

C5	281-0122-00	2.5-9 pF, Var.	Cer	100 V	
C6	283-0133-00	5 pF	Cer	50 V	5%
C7	283-0121-00	0.001 μ F	Cer	200 V	
C8	283-0196-00	270 pF	Cer	50 V	10%
C9	283-0196-00	270 pF	Cer	50 V	10%
C12	283-0133-00	5 pF	Cer	50 V	5%
C14	283-0196-00	270 pF	Cer	50 V	10%
C15	283-0196-00	270 pF	Cer	50 V	10%
C17	283-0175-00	10 pF	Cer	200 V	5%
C18	281-0123-00	5-25 pF, Var	Cer	100 V	
C35	283-0175-00	10 pF	Cer	200 V	5%
C62	283-0047-00	270 pF	Cer	500 V	5%
C65	283-0060-00	100 pF	Cer	200 V	5%
C68	283-0072-01	0.01 μ F	Cer		
C70	283-0175-00	10 pF	Cer	200 V	5%
C72	283-0201-00	27 pF	Cer	200 V	10%
C76	283-0141-00	200 pF	Cer	600 V	10%
C80	283-0121-00	0.001 μ F	Cer	200 V	
C82	283-0072-01	0.01 μ F	Cer		
C85	283-0072-01	0.01 μ F	Cer		
C86	283-0121-00	0.001 μ F	Cer	200 V	
C90	283-0121-00	0.001 μ F	Cer	200 V	
C92	283-0133-00	5 pF	Cer	50 V	5%
C94	283-0133-00	5 pF	Cer	50 V	5%
C120	283-0203-00	0.47 μ F	Cer	50 V	

A1 357 VERTICAL Circuit Board Assembly (cont)

Ckt. No.	Tektronix Part No.	Serial/Model No. Eff	No. Disc	Description
Capacitors (cont)				
C125	283-0067-00			0.001 μ F Cer 200 V 10%
C139	283-0067-00			0.001 μ F Cer 200 V 10%
C142	283-0178-00			0.1 μ F Cer 100 V +80%—20%
C145	283-0076-00			27 pF Cer 500 V 10%
C165	283-0076-00			27 pF Cer 500 V 10%
C195	290-0135-00			15 μ F Elect. 20 V
C196	283-0177-00			1 μ F Cer 25 V +80%—20%

Semiconductor Device, Diodes

CR6 } CR12 }	*152-0453-00	Tek made (matched pair)		
CR35	*152-0185-00	Silicon	Replaceable by 1N4152	
CR48	*152-0185-00	Silicon	Replaceable by 1N4152	
CR49	*152-0185-00	Silicon	Replaceable by 1N4152	
CR86	152-0451-00	Silicon	Snap-off	
CR87	*152-0322-00	Silicon	Tek Spec	
CR130	*152-0185-00	Silicon	Replaceable by 1N4152	
CR132	*152-0185-00	Silicon	Replaceable by 1N4152	
VR195	152-0243-00	Zener	1N965B 0.4 W 15 V 5%	

Connector

J65	131-0391-00	Receptacle, electrical 50 Ω		
-----	-------------	------------------------------------	--	--

Transistors

Q5	151-0225-00	Silicon	NPN	TO-18 2N3563
Q20A, B	151-1049-00	Silicon	FET	N channel, TO-71 dual
Q25	151-0224-00	Silicon	NPN	TO-18 2N3692
Q35	151-0276-00	Silicon	PNP	TO-92 2N5087
Q65	151-0190-00	Silicon	NPN	TO-92 2N3904
Q70	151-0188-00	Silicon	PNP	TO-92 2N3906
Q75	*153-0556-00	Silicon		TO-18 Avalanche selected
Q85	151-0164-00	Silicon	PNP	TO-5 2N5447
Q145	151-0279-00	Silicon	NPN	TO-39 SE7056
Q165	151-0279-00	Silicon	NPN	TO-39 SE7056

A1 357 VERTICAL Circuit Board Assembly (cont)

Ckt. No.	Tektronix Part No.	Serial/Model No. Eff	Disc	Description			
Resistors							
Resistors are fixed, composition, $\pm 10\%$ unless otherwise indicated.							
R1	317-0472-00		4.7 k Ω	1/8 W		5%	
R3	317-0511-00		510 Ω	1/8 W		5%	
R5	315-0124-00		120 k Ω	1/4 W		5%	
R6	317-0151-00		150 Ω	1/8 W		5%	
R7	317-0200-00		20 Ω	1/8 W		5%	
R8	317-0107-00		100 M Ω	1/8 W		5%	
R12	317-0151-00		150 Ω	1/8 W		5%	
R14	317-0107-00		100 M Ω	1/8 W		5%	
R20	321-0617-00		111 k Ω	1/8 W	Prec	1%	
R25	323-0351-00		44.2 k Ω	1/2 W	Prec	1%	
R26	321-0341-00		34.8 k Ω	1/8 W	Prec	1%	
R27	321-0320-00		21 k Ω	1/8 W	Prec	1%	
R32	321-0359-00		53.6 k Ω	1/8 W	Prec	1%	
R33	315-0474-00		470 k Ω	1/4 W		5%	
R34	321-0481-00		1 M Ω	1/8 W	Prec	1%	
R35	303-0223-00		22 k Ω	1 W		5%	
R36	317-0242-00		2.4 k Ω	1/8 W		5%	
R50	321-0319-00		20.5 k Ω	1/8 W	Prec	1%	
R52	315-0103-00		10 k Ω	1/4 W		5%	
R54	315-0104-00		100 k Ω	1/4 W		5%	
R57	315-0104-00		100 k Ω	1/4 W		5%	
R58	315-0104-00		100 k Ω	1/4 W		5%	
R65	315-0103-00		10 k Ω	1/4 W		5%	
R66	315-0103-00		10 k Ω	1/4 W		5%	
R68	315-0100-00		10 Ω	1/4 W		5%	
R70	315-0103-00		10 k Ω	1/4 W		5%	
R71	315-0102-00		1 k Ω	1/4 W		5%	
R75	317-0332-00		3.3 k Ω	1/8 W		5%	
R76	317-0332-00		3.3 k Ω	1/8 W		5%	
R77	301-0472-00		4.7 k Ω	1/2 W		5%	
R78	311-0609-00		2 k Ω , Var				
R79	301-0242-00		2.4 k Ω	1/2 W		5%	
R80	315-0101-00		100 Ω	1/4 W		5%	
R81	311-0607-00		10 k Ω , Var				
R82	315-0100-00		10 Ω	1/4 W		5%	
R85	308-0385-00		200 Ω	3 W	WW	5%	
R86	317-0390-00		39 Ω	1/8 W		5%	
R87	317-0222-00		2.2 k Ω	1/8 W		5%	
R90	317-0390-00		39 Ω	1/8 W		5%	
R92	317-0750-00		75 Ω	1/8 W		5%	

A1 357 VERTICAL Circuit Board Assembly (cont)

Ckt. No.	Tektronix Part No.	Serial/Model No. Eff	Disc	Description			
Resistors (cont)							
R94	317-0750-00		75 Ω	1/8 W		5%	
R96	317-0151-00		150 Ω	1/8 W		5%	
R98	317-0151-00		150 Ω	1/8 W		5%	
R122	315-0751-00		750 k Ω	1/4 W		5%	
R125	315-0472-00		4.7 k Ω	1/4 W		5%	
R127	315-0752-00		7.5 k Ω	1/4 W		5%	
R128	315-0104-00		100 k Ω	1/4 W		5%	
R130	321-0232-00		2.55 k Ω	1/8 W	Prec	1%	
R132	321-0452-00		499 k Ω	1/8 W	Prec	1%	
R134	321-0328-00		25.5 k Ω	1/8 W	Prec	1%	
R135	321-0280-00		8.06 k Ω	1/8 W	Prec	1%	
R136	321-0223-00		2.05 k Ω	1/8 W	Prec	1%	
R137	321-0405-00		162 k Ω	1/8 W	Prec	1%	
R138	315-0202-00		2 k Ω	1/4 W		5%	
R139	321-0289-00		10 k Ω	1/8 W	Prec	1%	
R140	323-0364-00		60.4 k Ω	1/2 W	Prec	1%	
R142	321-0231-00		2.49 k Ω	1/8 W	Prec	1%	
R144	315-0104-00		100 k Ω	1/4 W		5%	
R145	323-0364-00		60.4 k Ω	1/2 W	Prec	1%	
R148	315-0102-00		1 k Ω	1/4 W		5%	
R150	323-0358-00		52.3 k Ω	1/2 W	Prec	1%	
R152	315-0472-00		4.7 k Ω	1/4 W		5%	
R164	315-0104-00		100 k Ω	1/4 W		5%	
R165	323-0364-00		60.4 k Ω	1/2 W	Prec	1%	
R168	315-0102-00		1 k Ω	1/4 W		5%	
R170	323-0358-00		52.3 k Ω	1/2 W	Prec	1%	
R195	308-0052-00		6 k Ω	5 W	WW	5%	
Transformer							
T70	*120-0544-00			Toroid, two windings			
Integrated Circuit							
U50	*155-0035-00			Quad op amp, 16 pin, DIP			

A2 3S7 POSITION INDICATOR Circuit Board Assembly

Ckt. No.	Tektronix Part No.	Serial/Model No. Eff	No. Disc	Description
----------	--------------------	----------------------	----------	-------------

*670-0143-00 Complete Board

Transistors

Q155	151-0292-00	Silicon	NPN	TO-92 TIS100
Q175	151-0292-00	Silicon	NPN	TO-92 TIS100

Resistors

Resistors are fixed, composition, $\pm 10\%$ unless otherwise indicated.

R155	317-0473-00	47 k Ω	$\frac{1}{8}$ W	5%
R156	317-0274-00	270 k Ω	$\frac{1}{8}$ W	5%
R160	317-0106-00	10 M Ω	$\frac{1}{8}$ W	5%
R175	317-0473-00	47 k Ω	$\frac{1}{8}$ W	5%

3T7

CHASSIS

Values are fixed unless marked Variable.

Ckt. No.	Tektronix Part No.	Serial/Model No. Eff	No. Disc	Description
----------	--------------------	----------------------	----------	-------------

Capacitors

Tolerance $\pm 20\%$ unless otherwise indicated.

C526 } C527 } C528 }	*295-0140-00 283-0635-00	0.0099 μ F 950 pF 51 pF	PTM Mica	(matched to $\pm 1\%$) 100 V
----------------------------	-----------------------------	-----------------------------------	-------------	----------------------------------

Bulbs

DS286	150-0035-00	Neon, A1D T2
DS310	150-0035-00	Neon, A1D T2

Connectors

J215	136-0140-00	Socket, Banana Jack
J234	136-0140-00	Socket, Banana Jack
P21	131-0149-00	24 contact, male

Resistors

Resistors are fixed, composition, $\pm 10\%$ unless otherwise indicated.

R216	311-0173-00	100 k Ω , Var			
R250	311-1043-00	2 k Ω , Var			
R258	311-0328-00	1 k Ω , Var			
R285	311-0110-00	100 k Ω , Var			
R286	315-0104-00	100 k Ω	$\frac{1}{4}$ W		5%
R295	311-0342-00	50 k Ω , Var			
R296	311-0838-00	10 k Ω , Var			
R297	321-0289-00	10 k Ω	$\frac{1}{8}$ W	Prec	1%
R310	315-0104-00	100 k Ω	$\frac{1}{4}$ W		5%
R311 ¹	311-1107-00	5 k Ω , Var			
R312	315-0242-00	2.4 k Ω	$\frac{1}{4}$ W		5%
R314	321-0922-02	4.58 k Ω	$\frac{1}{8}$ W	Prec	$\frac{1}{2}\%$
R315	321-0920-02	99.67 k Ω	$\frac{1}{8}$ W	Prec	$\frac{1}{2}\%$
R316	321-0921-02	11.07 k Ω	$\frac{1}{8}$ W	Prec	$\frac{1}{2}\%$
R318	321-0724-03	13.6 k Ω	$\frac{1}{8}$ W	Prec	$\frac{1}{4}\%$
R320	321-0918-03	109.6 k Ω	$\frac{1}{8}$ W	Prec	$\frac{1}{4}\%$
R322	321-0919-03	1.107 k Ω	$\frac{1}{8}$ W	Prec	$\frac{1}{4}\%$
R324	321-0318-00	20 k Ω	$\frac{1}{8}$ W	Prec	1%
R326	321-0924-02	40 k Ω	$\frac{1}{8}$ W	Prec	$\frac{1}{2}\%$
R327	321-0924-02	40 k Ω	$\frac{1}{8}$ W	Prec	$\frac{1}{2}\%$

¹Furnished as a unit with 5311.

CHASSIS (cont)

Ckt. No.	Tektronix Part No.	Serial/Model No. Eff	Disc	Description
Resistors (cont)				
R328	321-0920-02			99.67 kΩ 1/8 W Prec 1/2%
R329	321-0923-02			25.1 kΩ 1/8 W Prec 1/2%
R360	315-0201-00			200 Ω 1/4 W 5%
R362	315-0511-00			510 Ω 1/4 W 5%
R364	321-0260-00			4.99 kΩ 1/8 W Prec 1%
R366	321-0231-00			2.49 kΩ 1/8 W Prec 1%
R368	321-0193-00			1 kΩ 1/8 W Prec 1%
R390	306-0122-00			1.2 kΩ 2 W 5%
R393	305-0562-00			5.6 kΩ 2 W 5%
R413	311-0328-00			1 kΩ, Var 2 W 5%
R526	315-0510-00			51 Ω 1/4 W 5%
R527	315-0510-00			51 Ω 1/4 W 5%
R528	315-0510-00			51 Ω 1/4 W 5%

Switches

Ckt. No.	Tektronix Part No.	Serial/Model No. Eff	Disc	Description
Wired or Unwired				
S210	260-1193-00			Rotary SCAN MODE
S265	260-0689-00			Push START
S285	260-0447-00			Slide PRESET
S295	260-1203-00			Push LOCATE
S311 ²				UNCAL
S320	Wired *262-0911-00			Rotary TIME/DIVISION
S320	260-1194-00			Rotary TIME/DIVISION

A3 3T7 SWEEP Circuit Board Assembly

*670-1275-00

Complete Board

Capacitors

Tolerance ±20% unless otherwise indicated.

C200	290-0183-00			1 μF Elect. 35 V 10%
C202	290-0134-00			22 μF Elect. 15 V 10%
C210	283-0196-00			270 pF Cer 50 V 10%
C224	283-0197-00			470 pF Cer 50 V 10%
C265	283-0003-00			0.01 μF Cer 150 V

²Furnished as a unit with R311.

A3 3T7 SWEEP Circuit Board Assembly (cont)

Ckt. No.	Tektronix Part No.	Serial/Model No. Eff	Disc	Description
Capacitors (cont)				
C266	283-0006-00			0.02 μF Cer 500 V
C267	283-0208-00			0.22 μF Cer 200 V 10%
C282	283-0006-00			0.02 μF Cer 500 V
C339	283-0178-00			0.1 μF Cer 100 V +80%—20%
C344	283-0067-00			0.001 μF Cer 200 V 10%
C350	283-0003-00			0.01 μF Cer 150 V
C392	290-0135-00			15 μF Elect. 20 V
C395	283-0111-00			0.1 μF Cer 50 V
C413	285-0702-00			0.033 μF PTM 100 V 5%
C416	283-0154-00			22 pF Cer 50 V 5%
C422	283-0140-00			4.7 pF Cer 50 V 5%
C425	283-0175-00			10 pF Cer 200 V 5%
C426	283-0176-00			0.0022 μF Cer 50 V
C430	283-0186-00			27 pF Cer 50 V 5%
C431	283-0177-00			1 μF Cer 25 V +80%—20%
C433	283-0060-00			100 pF Cer 200 V 5%
C435	285-0598-00			0.01 μF PTM 100 V 5%
C448	283-0060-00			100 pF Cer 200 V 5%
C458	283-0121-00			0.001 μF Cer 200 V
C459	283-0121-00			0.001 μF Cer 200 V
C520	283-0186-00			27 pF Cer 50 V 5%
C523	283-0121-00			0.001 μF Cer 200 V
C525	281-0160-00			7-25 pF, Var Cer 350 V
C545	283-0121-00			0.001 μF Cer 200 V
C555	283-0178-00			0.1 μF Cer 100 V +80%—20%
C556	283-0121-00			0.001 μF Cer 200 V
C557	283-0115-00			47 pF Cer 200 V 5%
C560	283-0003-00			0.01 μF Cer 150 V
C562	283-0060-00			100 pF Cer 200 V 5%
C564	283-0066-00			2.5 pF Cer 200 V
C565	283-0072-01			0.01 μF Cer 200 V
C572	283-0066-00			2.5 pF Cer 200 V
C576	283-0135-00			100 pF Cer

Semiconductor Device, Diodes

CR206	*152-0185-00	Silicon	Replaceable by 1N4152
CR207	*152-0185-00	Silicon	Replaceable by 1N4152
CR222	*152-0185-00	Silicon	Replaceable by 1N4152
CR225	*152-0185-00	Silicon	Replaceable by 1N4152
CR263	*152-0061-00	Silicon	Tek Spec

A3 3T7 SWEEP Circuit Board Assembly (cont)

A3 3T7 SWEEP Circuit Board Assembly (cont)

Ckt. No.	Tektronix Part No.	Serial/Model No. Eff	Disc	Description
Semiconductor Device, Diodes (cont)				
CR265	*152-0185-00		Silicon	Replaceable by 1N4152
CR266	*152-0185-00		Silicon	Replaceable by 1N4152
CR267	*152-0107-00		Silicon	Replaceable by 1N647
CR268	*152-0185-00		Silicon	Replaceable by 1N4152
CR282	*152-0185-00		Silicon	Replaceable by 1N4152
CR345	*152-0185-00		Silicon	Replaceable by 1N4152
CR408	*152-0185-00		Silicon	Replaceable by 1N4152
CR415	*152-0185-00		Silicon	Replaceable by 1N4152
CR416	*152-0185-00		Silicon	Replaceable by 1N4152
CR420	*152-0185-00		Silicon	Replaceable by 1N4152
CR437	*152-0185-00		Silicon	Replaceable by 1N4152
CR444	*152-0185-00		Silicon	Replaceable by 1N4152
CR450	*152-0185-00		Silicon	Replaceable by 1N4152
CR465	*152-0185-00		Silicon	Replaceable by 1N4152
CR470	*152-0185-00		Silicon	Replaceable by 1N4152
CR472	*152-0185-00		Silicon	Replaceable by 1N4152
CR522	*152-0322-00		Silicon	Tek Spec
CR523	*152-0322-00		Silicon	Tek Spec
CR540	*152-0185-00		Silicon	Replaceable by 1N4152
CR542	*152-0185-00		Silicon	Replaceable by 1N4152
CR550	*152-0185-00		Silicon	Replaceable by 1N4152
CR552	*152-0185-00		Silicon	Replaceable by 1N4152
CR555	152-0169-00		Tunnel	1N3712 1 mA
CR557	*152-0185-00		Silicon	Replaceable by 1N4152
CR558	*152-0185-00		Silicon	Replaceable by 1N4152
CR560	*152-0185-00		Silicon	Replaceable by 1N4152
VR225	152-0168-00		Zener	1N963A 400 mW, 12 V, 5%
VR392	152-0024-00		Zener	1N3024B 1 W, 15 V, 5%
VR459	152-0395-00		Zener	1N749A 400 mW, 4.3 V, 5%
Connectors				
J459	131-0391-00			Receptacle, electrical, 50 Ω
J470	131-0391-00			Receptacle, electrical, 50 Ω
J525	131-0265-00			Coaxial, right angle
J557	131-0391-00			Receptacle, electrical, 50 Ω
J570	131-0391-00			Receptacle, electrical, 50 Ω
Transistors				
Q200	151-1021-00		Silicon	FET TO-18 N channel, junction type
Q245	151-0279-00		Silicon	NPN TO-39 SE7056
Q255	151-0279-00		Silicon	NPN TO-39 SE7056
Q260	151-0220-00		Silicon	PNP TO-18 2N4122
Q265	*151-0150-00		Silicon	NPN TO-5 Selected from 2N3440

Ckt. No.	Tektronix Part No.	Serial/Model No. Eff	Disc	Description
Transistors (cont)				
Q275	151-0220-00		Silicon	PNP TO-18 2N4122
Q280	151-0220-00		Silicon	PNP TO-18 2N4122
Q290	151-0224-00		Silicon	NPN TO-18 2N3692
Q293	151-0188-00		Silicon	PNP TO-92 2N3906
Q295	151-0188-00		Silicon	PNP TO-92 2N3906
Q335	151-0220-00		Silicon	PNP TO-18 2N4122
Q340	151-0220-00		Silicon	PNP TO-18 2N4122
Q350	151-0220-00		Silicon	PNP TO-18 2N4122
Q398	151-0224-00		Silicon	NPN TO-18 2N3692
Q405	151-0224-00		Silicon	NPN TO-18 2N3692
Q430	151-0188-00		Silicon	PNP TO-92 2N3906
Q435	151-1021-00		Silicon	FET TO-18 N channel, junction type
Q437	151-1004-00		Silicon	FET TO-18 N channel, junction type
Q438	151-1004-00		Silicon	FET TO-18 N channel, junction type
Q440	151-0190-00		Silicon	NPN TO-92 2N3904
Q445	151-0190-00		Silicon	NPN TO-92 2N3904
Q520	151-0221-00		Silicon	PNP TO-18 2N4258
Q525	*151-0325-00		Silicon	PNP TO-106 Selected from 2N4258
Q530	151-0225-00		Silicon	NPN TO-18 2N3563
Q540	*151-0192-00		Silicon	NPN TO-92 Replaceable by MPS 6521
Q545	*151-0192-00		Silicon	NPN TO-92 Replaceable by MPS 6521
Q550	151-0225-00		Silicon	NPN TO-18 2N3563
Q555	151-0225-00		Silicon	NPN TO-18 2N3563
Q557	151-0131-00		Germanium	PNP TO-18 2N964
Q560	151-0188-00		Silicon	PNP TO-92 2N3906
Q562	*151-0269-00		Silicon	NPN TO-106 Selected from SE3005
Q575	*151-0271-00		Silicon	PNP TO-18 Tek Spec
Resistors				
Resistors are fixed, composition, ±10% unless otherwise indicated.				
R204	321-0381-00			90.9 kΩ 1/8 W Prec 1%
R206	311-0607-00			10 kΩ, Var 1/8 W Prec 1%
R207	321-0408-00			174 kΩ 1/8 W Prec 1%
R208	321-0314-00			18.2 kΩ 1/8 W Prec 1%
R210	315-0471-00			470 Ω 1/4 W 5%
R215	321-0289-00			10 kΩ 1/8 W Prec 1%
R218	321-0289-00			10 kΩ 1/8 W Prec 1%
R220	323-0385-00			100 kΩ 1/2 W Prec 1%
R222	315-0103-00			10 kΩ 1/4 W 5%
R224	315-0102-00			1 kΩ 1/4 W 5%
R225	315-0104-00			100 kΩ 1/4 W 5%
R230	321-0289-00			10 kΩ 1/8 W Prec 1%
R245	323-0364-00			60.4 kΩ 1/2 W Prec 1%
R247	323-0358-00			52.3 kΩ 1/2 W Prec 1%
R248	315-0622-00			6.2 kΩ 1/4 W 5%

A3 3T7 SWEEP Circuit Board Assembly (cont)

A3 3T7 SWEEP Circuit Board Assembly (cont)

Ckt. No.	Tektronix Part No.	Serial/Model No. Eff	Disc	Description			
Resistors (cont)							
R252	323-0358-00			52.3 kΩ	1/2 W	Prec	1%
R255	323-0364-00			60.4 kΩ	1/2 W	Prec	1%
R257	323-0363-00			59 kΩ	1/2 W	Prec	1%
R259	315-0202-00			2 kΩ	1/4 W		5%
R260	315-0103-00			10 kΩ	1/4 W		5%
R261	315-0243-00			24 kΩ	1/4 W		5%
R262	315-0103-00			10 kΩ	1/4 W		5%
R263	315-0103-00			10 kΩ	1/4 W		5%
R264	315-0513-00			51 kΩ	1/4 W		5%
R265	315-0105-00			1 MΩ	1/4 W		5%
R266	315-0204-00			200 kΩ	1/4 W		5%
R267	315-0102-00			1 kΩ	1/4 W		5%
R268	315-0470-00			47 Ω	1/4 W		5%
R270	315-0823-00			82 kΩ	1/4 W		5%
R273	315-0203-00			20 kΩ	1/4 W		5%
R274	315-0683-00			68 kΩ	1/4 W		5%
R275	321-0391-00			115 kΩ	1/8 W	Prec	1%
R280	321-0290-00			10.2 kΩ	1/8 W	Prec	1%
R282	321-0385-00			100 kΩ	1/8 W	Prec	1%
R288	311-1035-00			50 kΩ, Var			
R290	321-0402-00			150 kΩ	1/8 W	Prec	1%
R293	322-0289-00			10 kΩ	1/4 W	Prec	1%
R294	322-0289-00			10 kΩ	1/4 W	Prec	1%
R299	315-0625-00			6.2 MΩ	1/4 W		5%
R334	323-0474-00			845 kΩ	1/2 W	Prec	1%
R335	321-0289-00			10 kΩ	1/8 W	Prec	1%
R337	315-0102-00			1 kΩ	1/4 W		5%
R338	301-0513-00			51 kΩ	1/2 W		5%
R340	323-0474-00			845 kΩ	1/2 W	Prec	1%
R341	321-0289-00			10 kΩ	1/8 W	Prec	1%
R342	301-0513-00			51 kΩ	1/2 W		5%
R343	315-0102-00			1 kΩ	1/4 W		5%
R344	315-0101-00			100 Ω	1/4 W		5%
R345	315-0164-00			160 kΩ	1/4 W		5%
R346	315-0563-00			56 kΩ	1/4 W		5%
R348	323-0381-00			90.9 kΩ	1/2 W	Prec	1%
R350	315-0102-00			1 kΩ	1/4 W		5%
R392	308-0051-00			4 kΩ	5 W	WW	5%
R395	321-0289-00			10 kΩ	1/8 W	Prec	1%
R398	323-0379-00			86.6 kΩ	1/2 W	Prec	1%
R401	315-0393-00			39 kΩ	1/4 W		5%
R403	315-0333-00			33 kΩ	1/4 W		5%
R405	315-0432-00			4.3 kΩ	1/4 W		5%
R406	315-0243-00			24 kΩ	1/4 W		5%
R407	315-0911-00			910 Ω	1/4 W		5%

Ckt. No.	Tektronix Part No.	Serial/Model No. Eff	Disc	Description			
Resistors (cont)							
R408	315-0183-00			18 kΩ	1/4 W		5%
R410	315-0133-00			13 kΩ	1/4 W		5%
R411	315-0332-00			3.3 kΩ	1/4 W		5%
R412	311-0633-00			5 kΩ, Var			
R415	315-0103-00			10 kΩ	1/4 W		5%
R416	315-0104-00			100 kΩ	1/4 W		5%
R417	315-0102-00			1 kΩ	1/4 W		5%
R418	315-0102-00			1 kΩ	1/4 W		5%
R420	315-0133-00			13 kΩ	1/4 W		5%
R422	315-0104-00			100 kΩ	1/4 W		5%
R425	315-0473-00			47 kΩ	1/4 W		5%
R426	315-0103-00			10 kΩ	1/4 W		5%
R428	315-0103-00			10 kΩ	1/4 W		5%
R430	315-0103-00			10 kΩ	1/4 W		5%
R432	315-0103-00			10 kΩ	1/4 W		5%
R433	315-0103-00			10 kΩ	1/4 W		5%
R437	315-0304-00			300 kΩ	1/4 W		5%
R438	315-0103-00			10 kΩ	1/4 W		5%
R440	308-0412-00			8.2 kΩ	3 W	WW	1%
R442	303-0162-00			1.6 kΩ	1 W		5%
R444	315-0243-00			24 kΩ	1/4 W		5%
R445	315-0114-00			110 kΩ	1/4 W		5%
R447	315-0153-00			15 kΩ	1/4 W		5%
R448	315-0103-00			10 kΩ	1/4 W		5%
R450	315-0124-00			120 kΩ	1/4 W		5%
R455	315-0243-00			24 kΩ	1/4 W		5%
R457	308 0391-00			7.2 kΩ	3 W	WW	1%
R458	315-0470-00			47 Ω	1/4 W		5%
R459	315-0124-00			120 kΩ	1/4 W		5%
R465	315-0754-00			750 kΩ	1/4 W		5%
R466	315-0124-00			120 kΩ	1/4 W		5%
R468	315-0243-00			24 kΩ	1/4 W		5%
R470	315-0125-00			1.2 MΩ	1/4 W		5%
R471	315-0392-00			3.9 kΩ	1/4 W		5%
R472	315-0103-00			10 kΩ	1/4 W		5%
R520	315-0103-00			10 kΩ	1/4 W		5%
R521	315-0104-00			100 kΩ	1/4 W		5%
R522	315-0223-00			22 kΩ	1/4 W		5%
R523	315-0100-00			10 Ω	1/4 W		5%

A3 3T7 SWEEP Circuit Board Assembly (cont)

Ckt. No.	Tektronix Part No.	Serial/Model No. Eff	No. Disc	Description		
Resistors (cont)						
R524	315-0473-00			47 kΩ	1/4 W	5%
R525	315-0101-00			100 Ω	1/4 W	5%
R529	315-0104-00			100 kΩ	1/4 W	5%
R530	308-0461-00			16 kΩ	4 W	1%
R531	315-0823-00			82 kΩ	1/4 W	5%
					WW	
R532	311-0609-00			2 kΩ, Var		
R540	303-0183-00			18 kΩ	1 W	5%
R541	315-0271-00			270 Ω	1/4 W	5%
R544	321-0246-00			3.57 kΩ	1/8 W	1%
R545	315-0103-00			10 kΩ	1/4 W	5%
R546	311-0607-00			10 kΩ, Var		
R547	311-0607-00			10 kΩ, Var		
R548	311-0607-00			10 kΩ, Var		
R549	321-0434-00			324 kΩ	1/8 W	1%
R550	303-0183-00			18 kΩ	1 W	5%
					Prec	
R557	315-0103-00			10 kΩ	1/4 W	5%
R560	315-0106-00			10 MΩ	1/4 W	5%
R562	315-0103-00			10 kΩ	1/4 W	5%
R564	315-0103-00			10 kΩ	1/4 W	5%
R565	315-0100-00			10 Ω	1/4 W	5%
R567	315-0103-00			10 kΩ	1/4 W	5%
R572	315-0103-00			10 kΩ	1/4 W	5%
R573	315-0103-00			10 kΩ	1/4 W	5%
R576	317-0510-00			51 Ω	1/8 W	5%
R590	311-0635-00			1 kΩ, Var		
Integrated Circuits						
U210	*155-0035-00			Quad op amp, 16 pin, DIP		
U270	156-0048-00			Linear. Replaceable by RCA CA3046		
U345	156-0095-00			Dual diff amp. Replaceable by RCA CA3051		
U395	*155-0035-00			Quad op amp, 16 pin, DIP		

A4 3T7 PULSER Circuit Board Assembly

*670-0963-00

Complete Board

Capacitors

Tolerance ±20% unless otherwise indicated.

C584	283-0135-00			100 pF	Cer	
C585	283-0121-00			0.001 μF	Cer	200 V
C587 ^a						

^aPart of Circuit Board.

A4 3T7 PULSER Circuit Board Assembly (cont)

Ckt. No.	Tektronix Part No.	Serial/Model No. Eff	No. Disc	Description		
Capacitors (cont)						
C589	283-0121-00			0.001 μF	Cer	200 V
Semiconductor Device, Diode						
CR587	152-0489-00			Tunnel, assembly		
Connectors						
J580	131-0548-00			Receptacle, electrical, snap-on		
J587	132-0145-00			Receptacle, electrical		
Transistor						
Q585	151-0202-00			Silicon	PNP	TO-72 2N4261
Resistors						
Resistors are fixed, composition, ±10% unless otherwise indicated.						
R583	317-0470-00			47 Ω	1/8 W	5%
R584	317-0102-00			1 kΩ	1/8 W	5%
R585	317-0101-00			100 Ω	1/8 W	5%
R586	307-0299-00			100 Ω	1/4 W	1%
R587	307-0299-00			100 Ω	1/4 W	1%
R588	317-0392-00			39 kΩ	1/8 W	5%

SECTION 8

DIAGRAMS AND CIRCUIT BOARD ILLUSTRATIONS

Symbols and Reference Designators

Electrical components shown on the diagrams are in the following units unless noted otherwise:

Capacitors = Values one or greater are in picofarads (pF).
 Values less than one are in microfarads (μ F).
 Resistors = Ohms (Ω)

Symbols used on the diagrams are based on USA Standard Y32.2-1967.

Logic symbology is based on MIL-STD-806B in terms of positive logic. Logic symbols depict the logic function performed and may differ from the manufacturer's data.

The following special symbols are used on the diagrams:

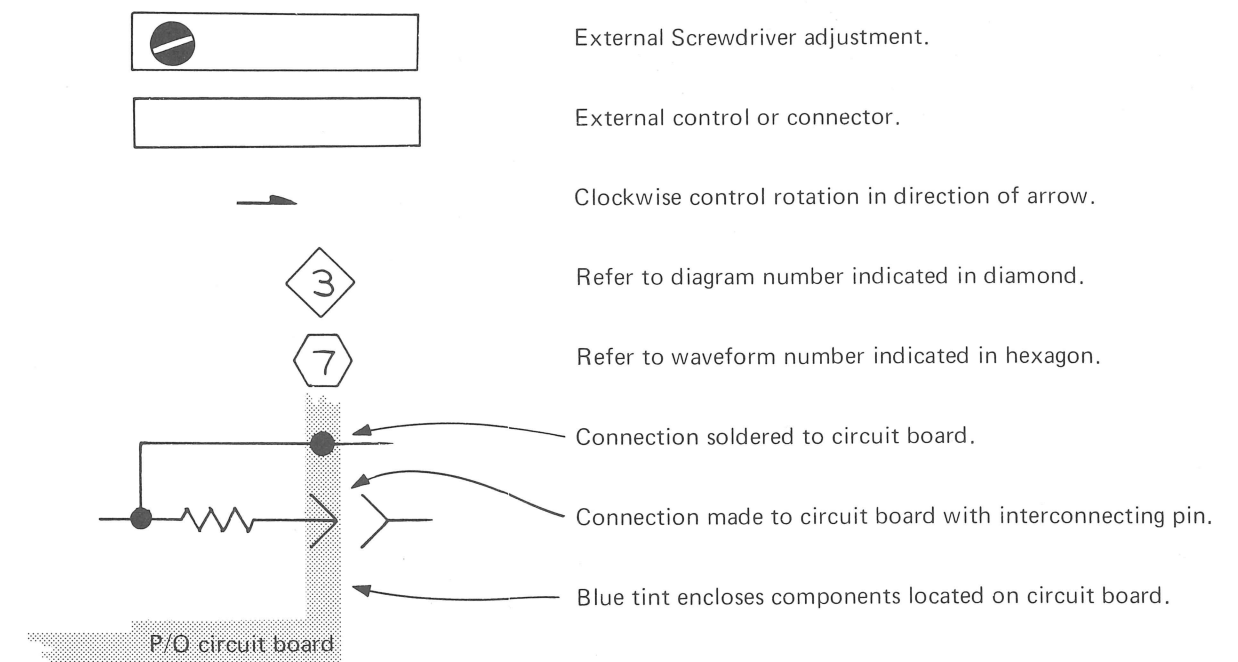

The following prefix letters are used as reference designators to identify components or assemblies on the diagrams.

A	Assembly, separable or repairable (circuit board, etc.)	LR	Inductor/resistor combination
AT	Attenuator, fixed or variable	M	Meter
B	Motor	Q	Transistor or silicon-controlled rectifier
BT	Battery	P	Connector, movable portion
C	Capacitor, fixed or variable	R	Resistor, fixed or variable
CR	Diode, signal or rectifier	RT	Thermistor
DL	Delay line	S	Switch
DS	Indicating device (lamp)	T	Transformer
F	Fuse	TP	Test point
FL	Filter	U	Assembly, inseparable or non-repairable (integrated circuit, etc.)
H	Heat dissipating device (heat sink, heat radiator, etc.)	V	Electron tube
HR	Heater	VR	Voltage regulator (zener diode, etc.)
J	Connector, stationary portion	Y	Crystal
K	Relay		
L	Inductor, fixed or variable		

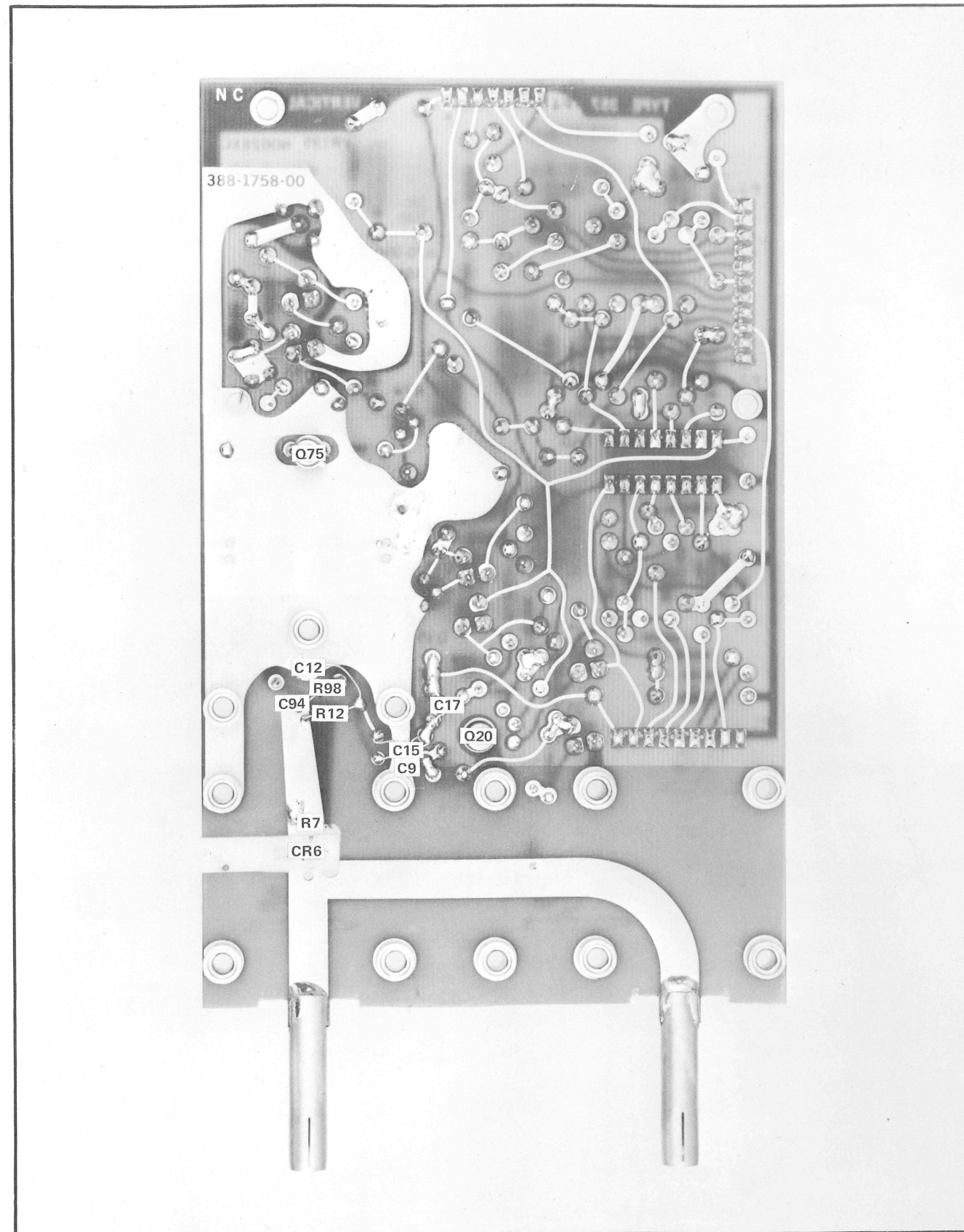

A1 3S7 Vertical circuit board (back).

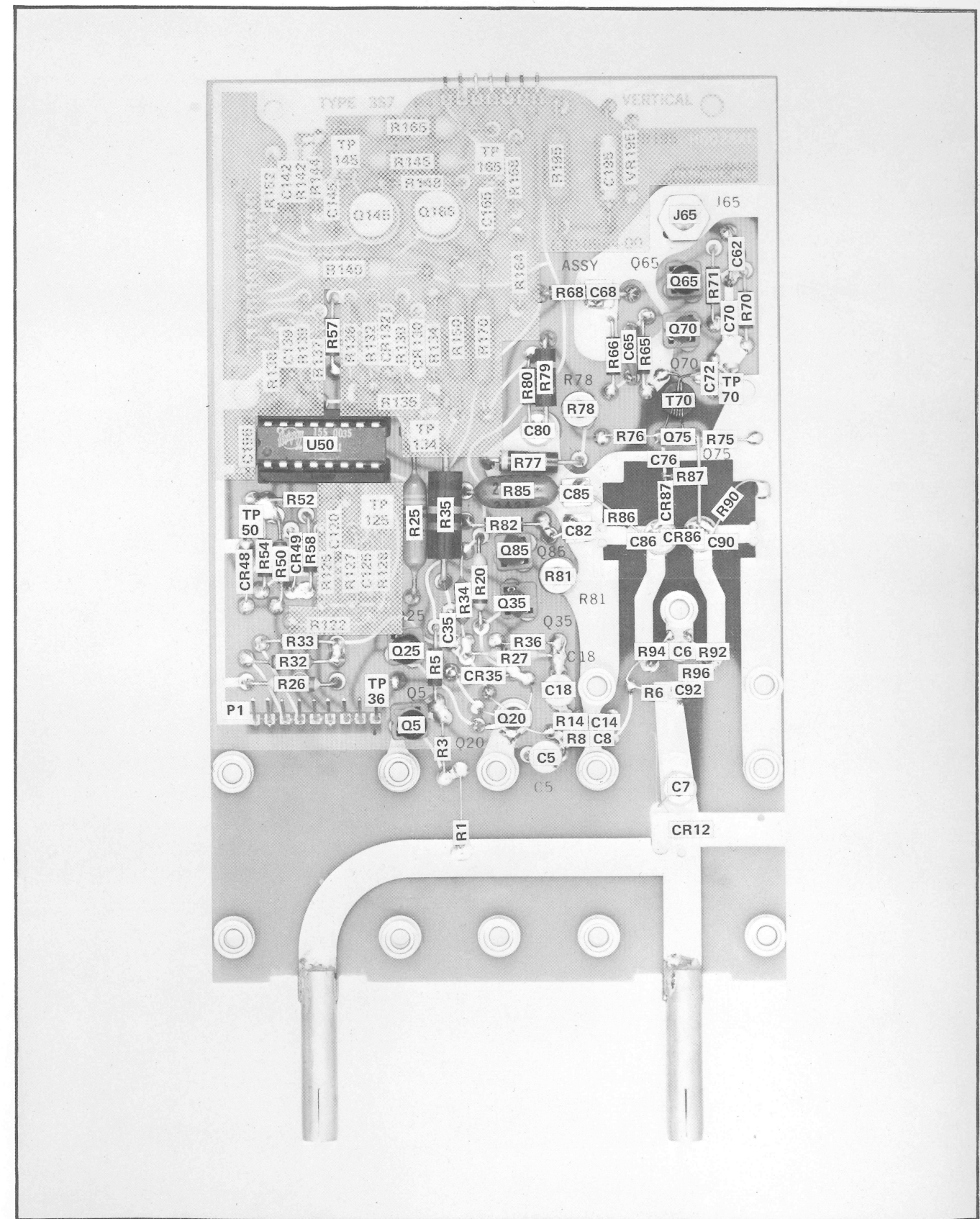

A1 3S7 Vertical circuit board (front).

VOLTAGE AND WAVEFORM TEST CONDITIONS

Typical voltage measurements and waveform photographs (shown in blue) were obtained under the following conditions. The 3S7 TDR Sampler was connected to the indicator oscilloscope Vertical compartment by a Plug-in Unit Extender cable (Tektronix Part No. 012-0064-00) to permit access to the Vertical circuit board. The 3S7 TDR Sampler TEST LINE connector was terminated with a GR 50 Ω termination. The 3T7 TDR Sweep was installed in the Horizontal compartment of the indicator oscilloscope. The right side panel was removed to permit access to the Type 3T7 Sweep circuit board. A coaxial cable was connected from the 3S7 TDR Sampler PULSE IN connector to the 3T7 TDR Sweep PULSE OUT connector. The 3S7 TDR Sampler and the coaxial cable are not required when only the waveforms of the 3T7 TDR Sweep are observed. The 3T7 Sweep may be connected to the Horizontal compartment by a Plug-in Unit Extender cable.

Test Oscilloscope (with Differential Comparator)

Bandwidth 10 MHz

Probe (Tektronix P6012)

Attenuation 10X
 Input Capacitance 11.5 μF
 Input Impedance 10 MΩ

3S7 TDR Sampler Control Settings

UNITS mV
 UNITS/DIV 50
 RESOLUTION NORMAL
 POLARITY +UP
 DC OFFSET Center no-signal trace or bottom of step

3T7 TDR Sweep Control Settings

TIME/DIV 1 μs
 PRESET right position
 TIME-DISTANCE 0
 FINE fully clockwise
 SCAN MODE REPETITIVE
 VARIABLE OR EXT ATTEN fully clockwise
 SAMPLING RATE mid position

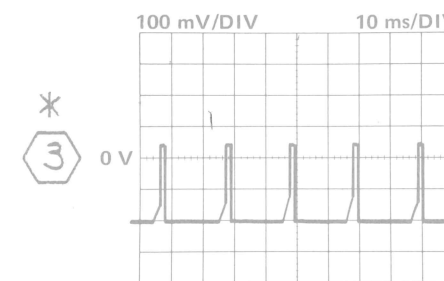
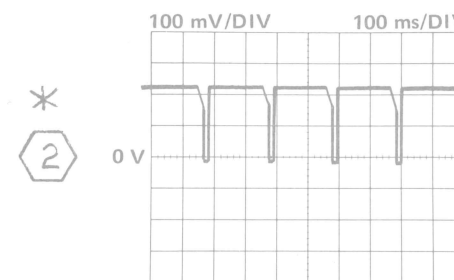
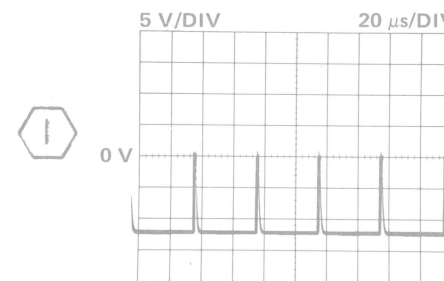

WAVEFORM conditions are given on page 8-4 except as follows:

*NOTE

The waveform at the end of each pulse (see illustration) should be ignored. Your Sampler may have a different waveform.

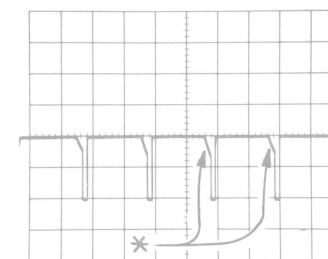

← WAVEFORMS

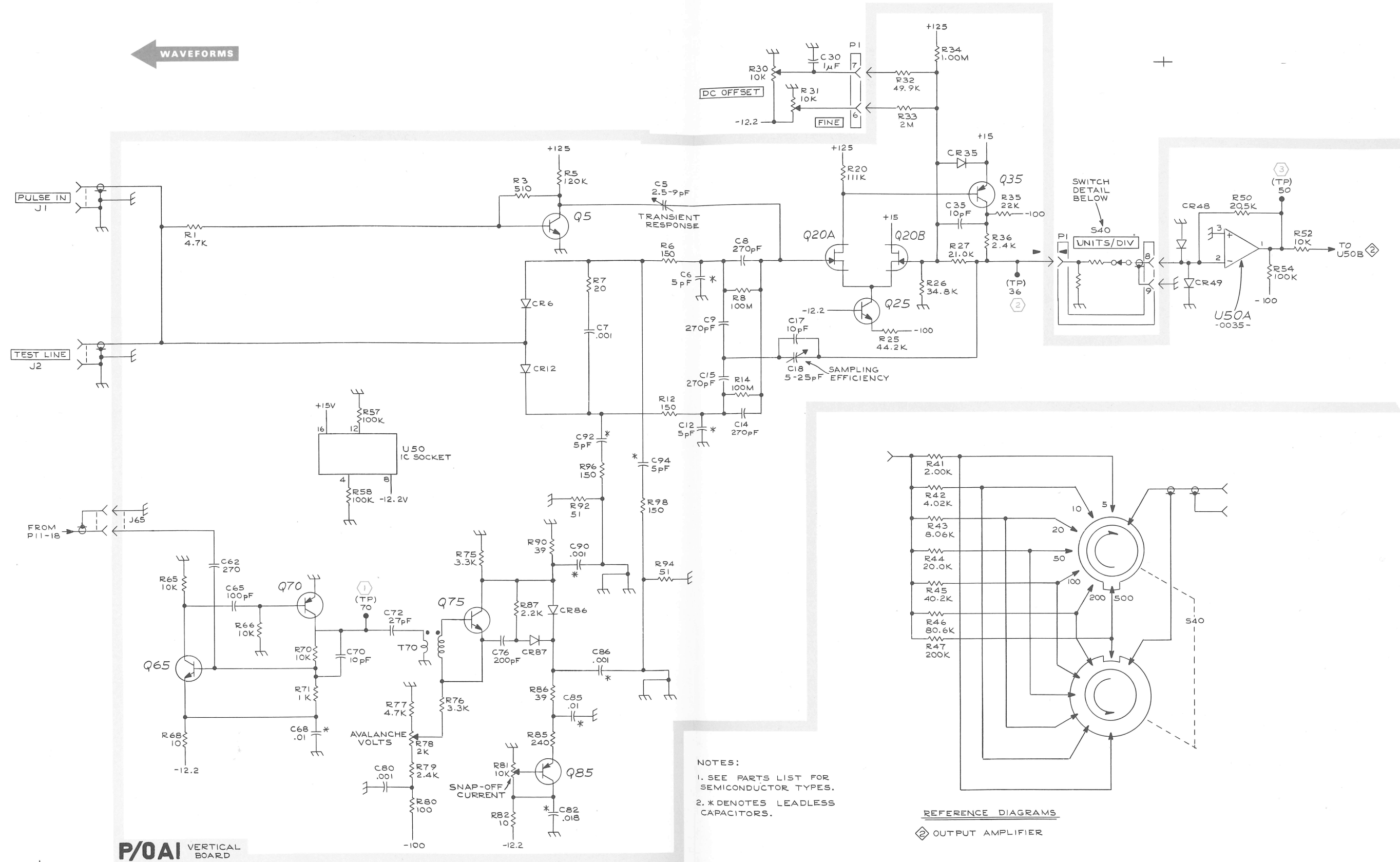

P/OAI VERTICAL BOARD

- NOTES:
1. SEE PARTS LIST FOR SEMICONDUCTOR TYPES.
 2. * DENOTES LEADLESS CAPACITORS.

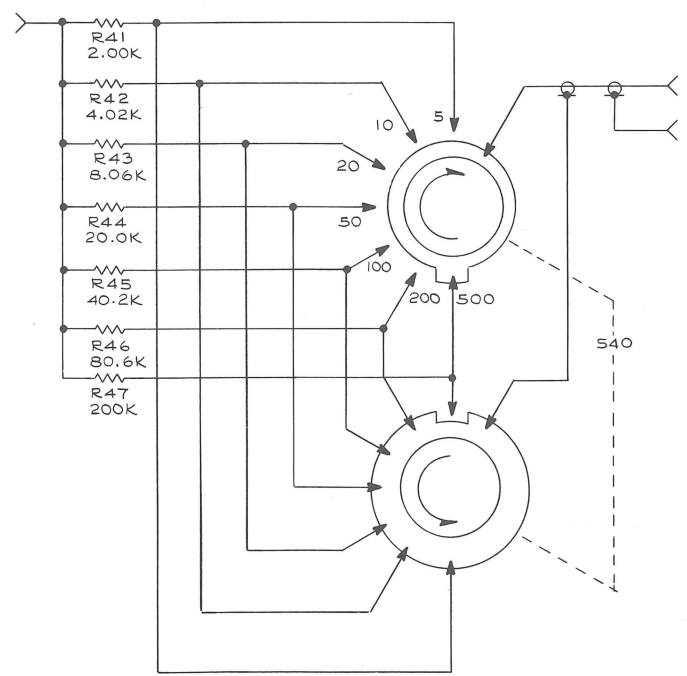

REFERENCE DIAGRAMS
 ⊠ OUTPUT AMPLIFIER

3S7 SAMPLER

1 LAY

10 ms

10 ms

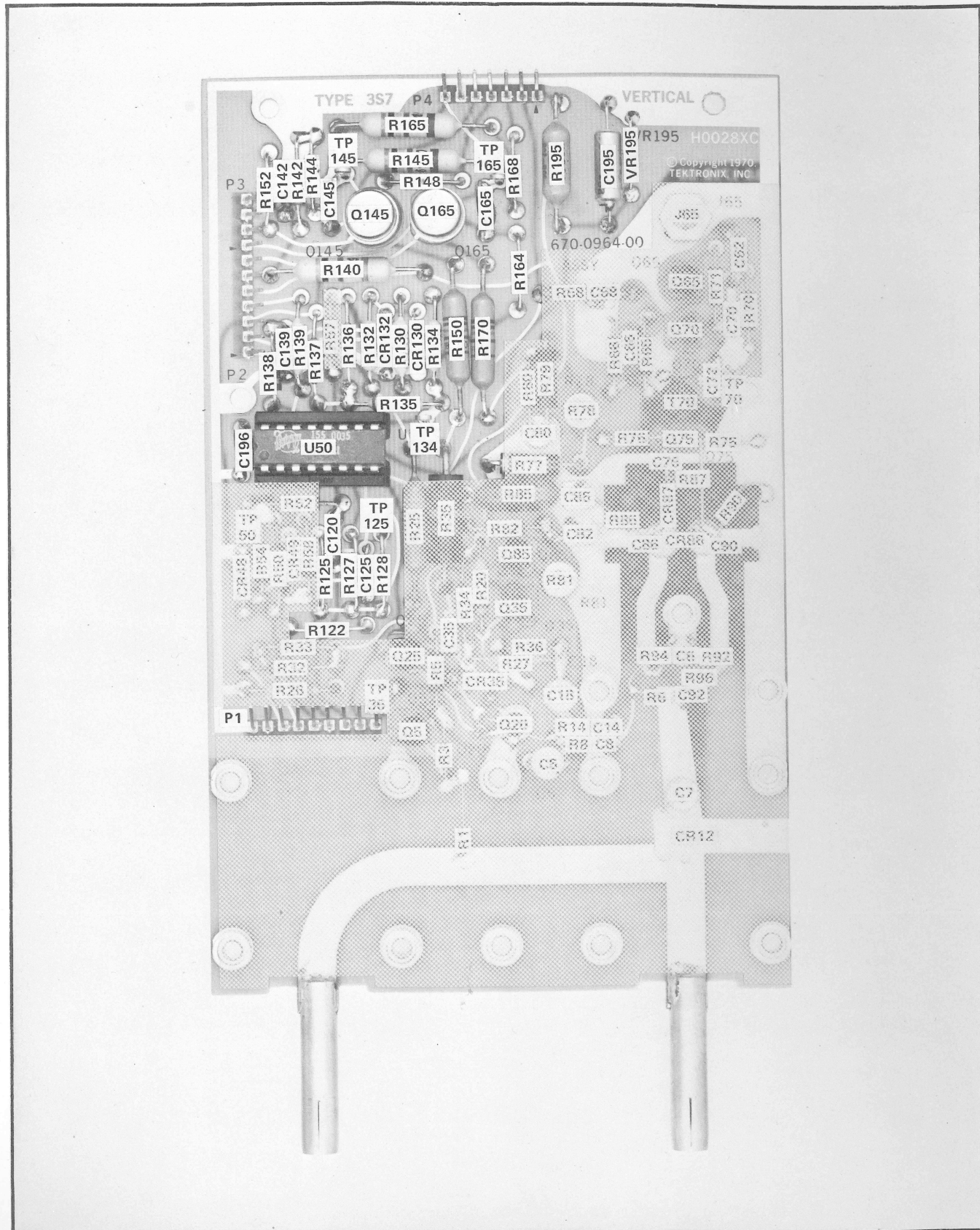

A1 3S7 Vertical circuit board (front).

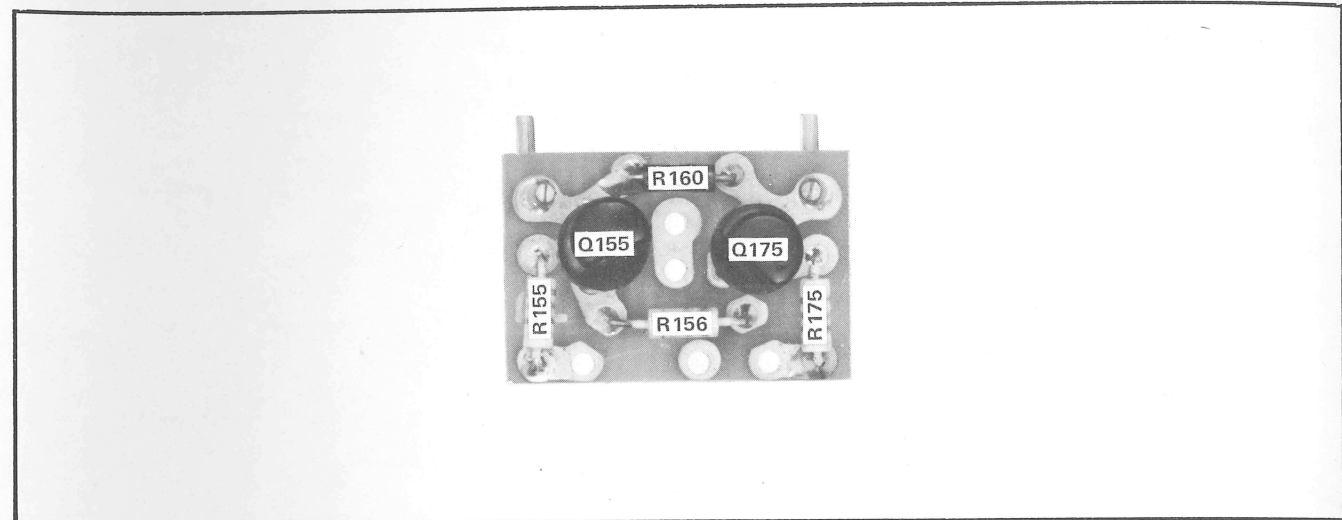

A2 Position Indicator Board.

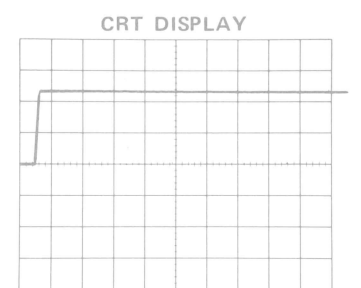
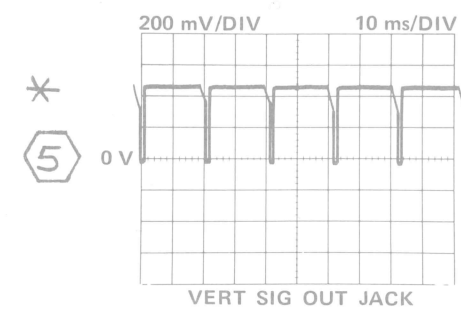
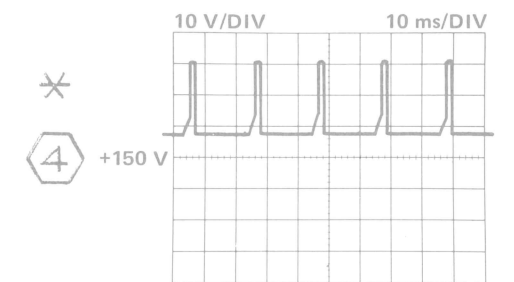
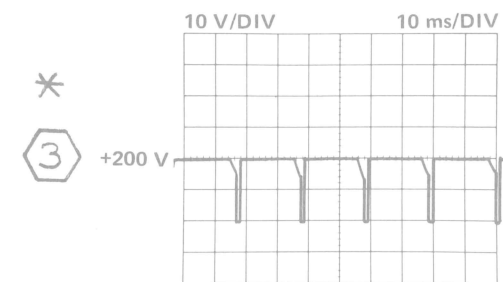
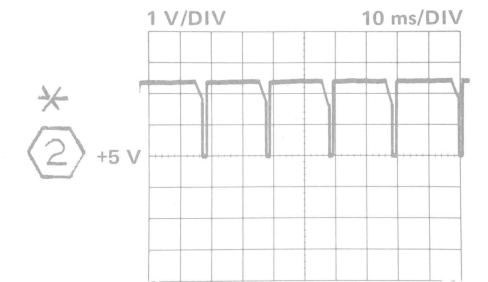
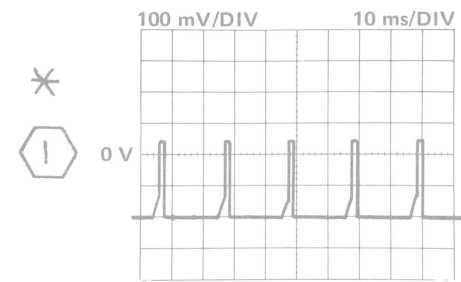

WAVEFORM conditions are given on page 8-4 except as follows:

***NOTE**

The waveform at the end of each pulse (see illustration) should be ignored. Your Sampler may have a different waveform.

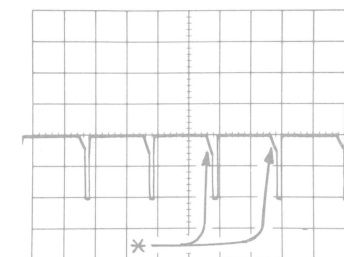

← WAVEFORMS

REFERENCE DIAGRAM

◇ SAMPLER

NOTES:
SEE PARTS LIST FOR SEMICONDUCTOR TYPES.

357

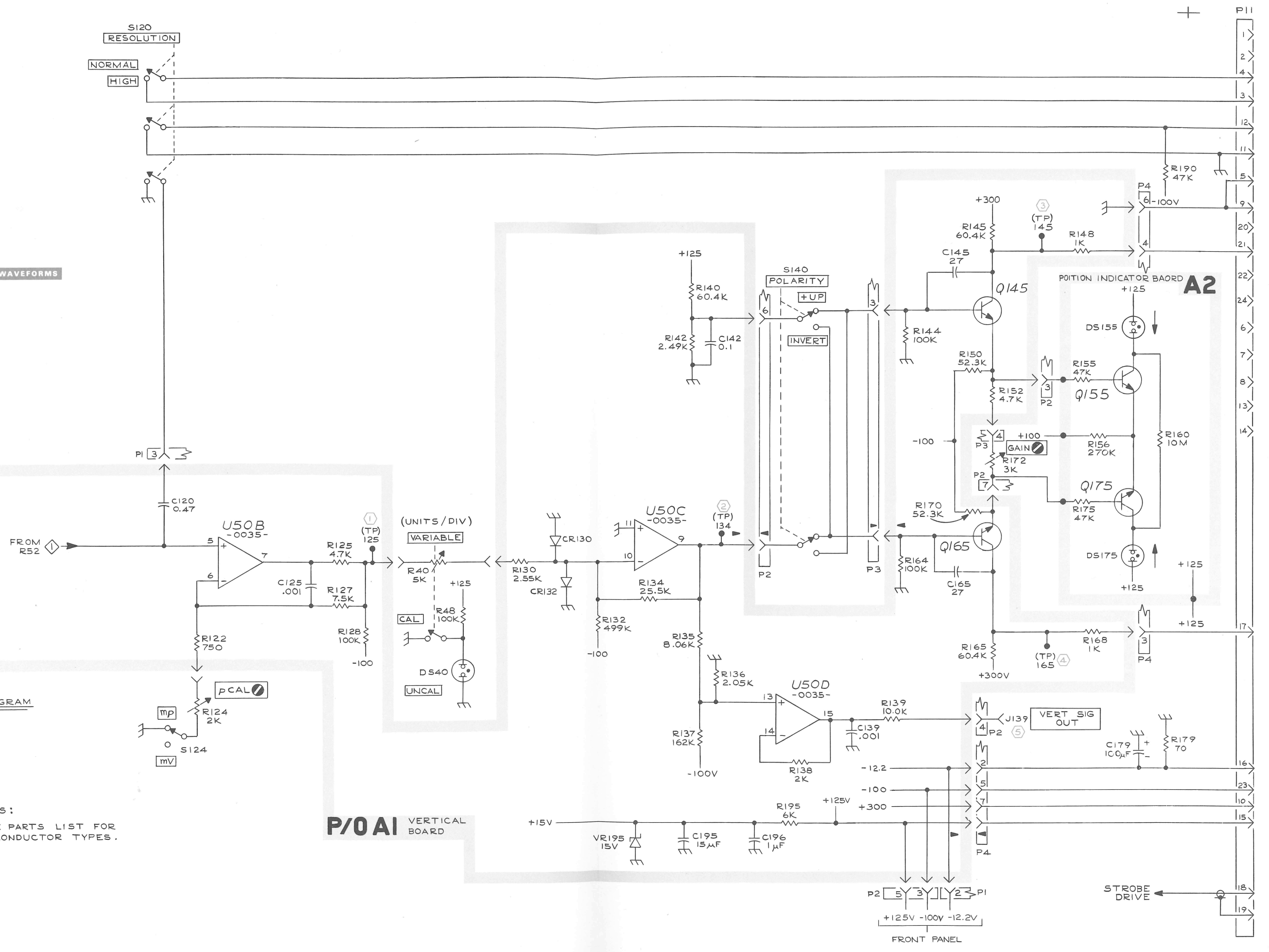

10 ms/DIV

10 ms/D

357 OUTPUT AMPLIFIER

2

ven on p

OUTPUT AMPLIFIER ② 0171 VFS

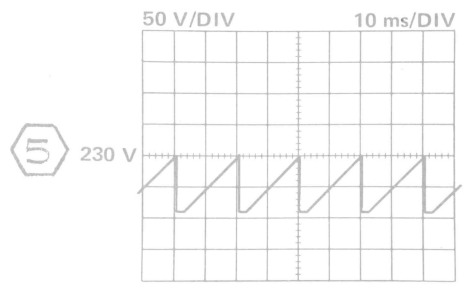
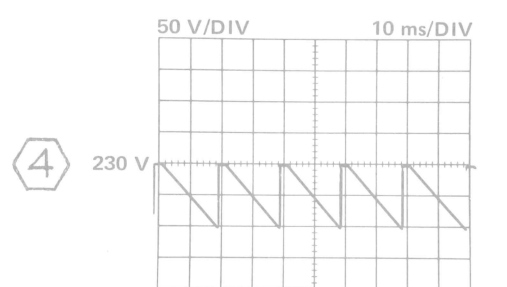
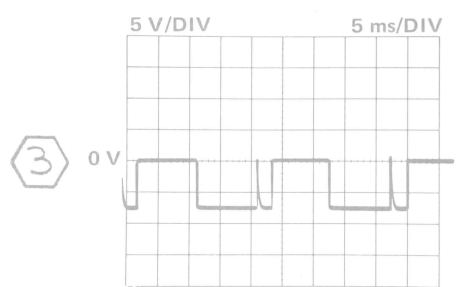
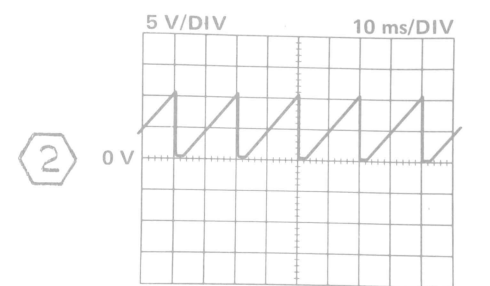
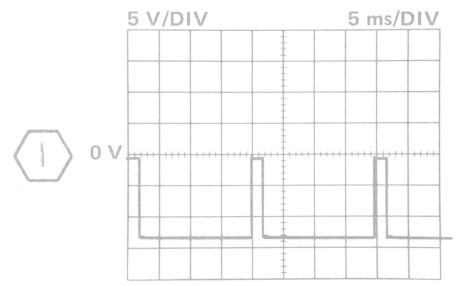
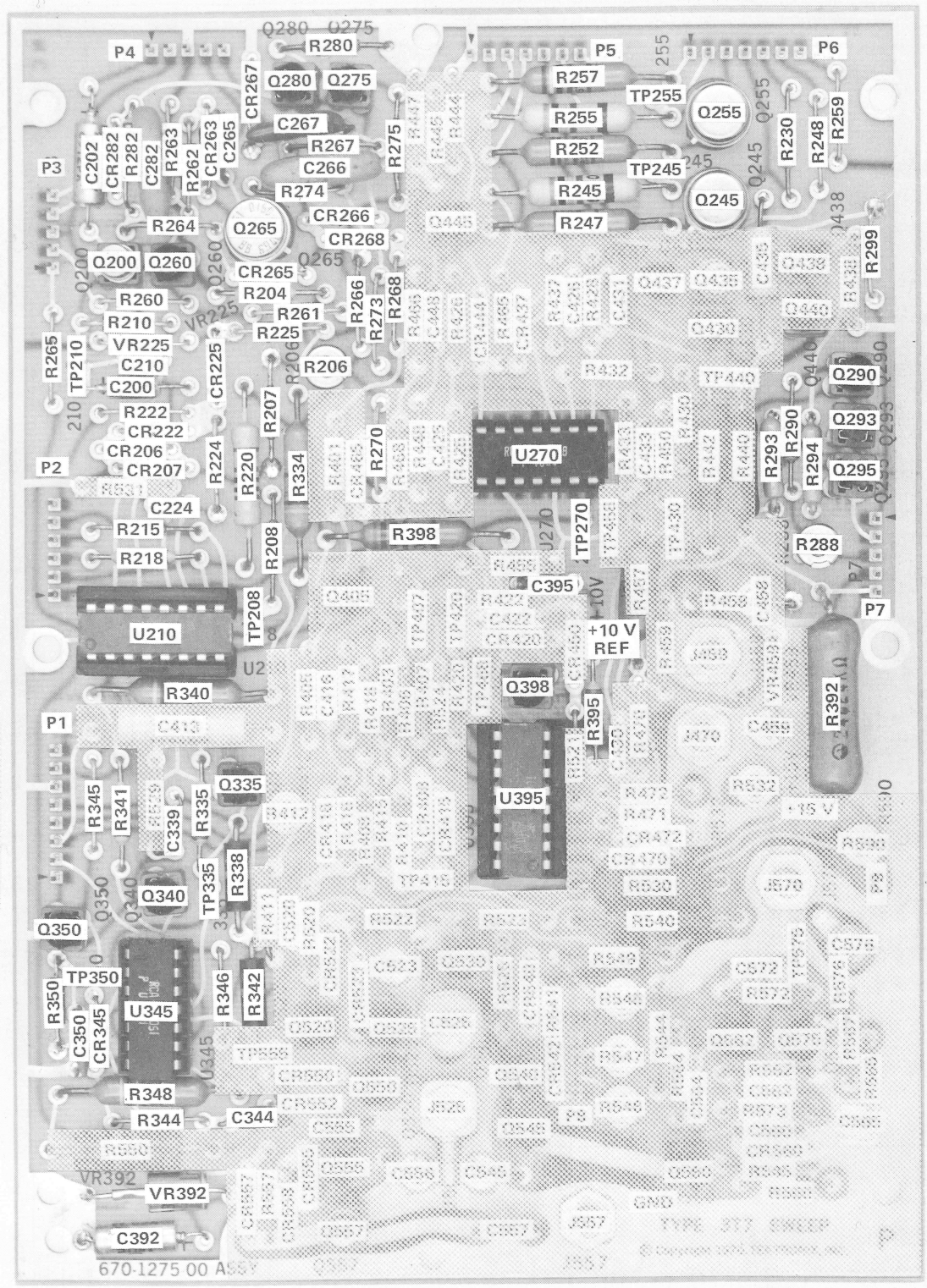

WAVEFORM conditions given on page 8-4

← WAVEFORMS

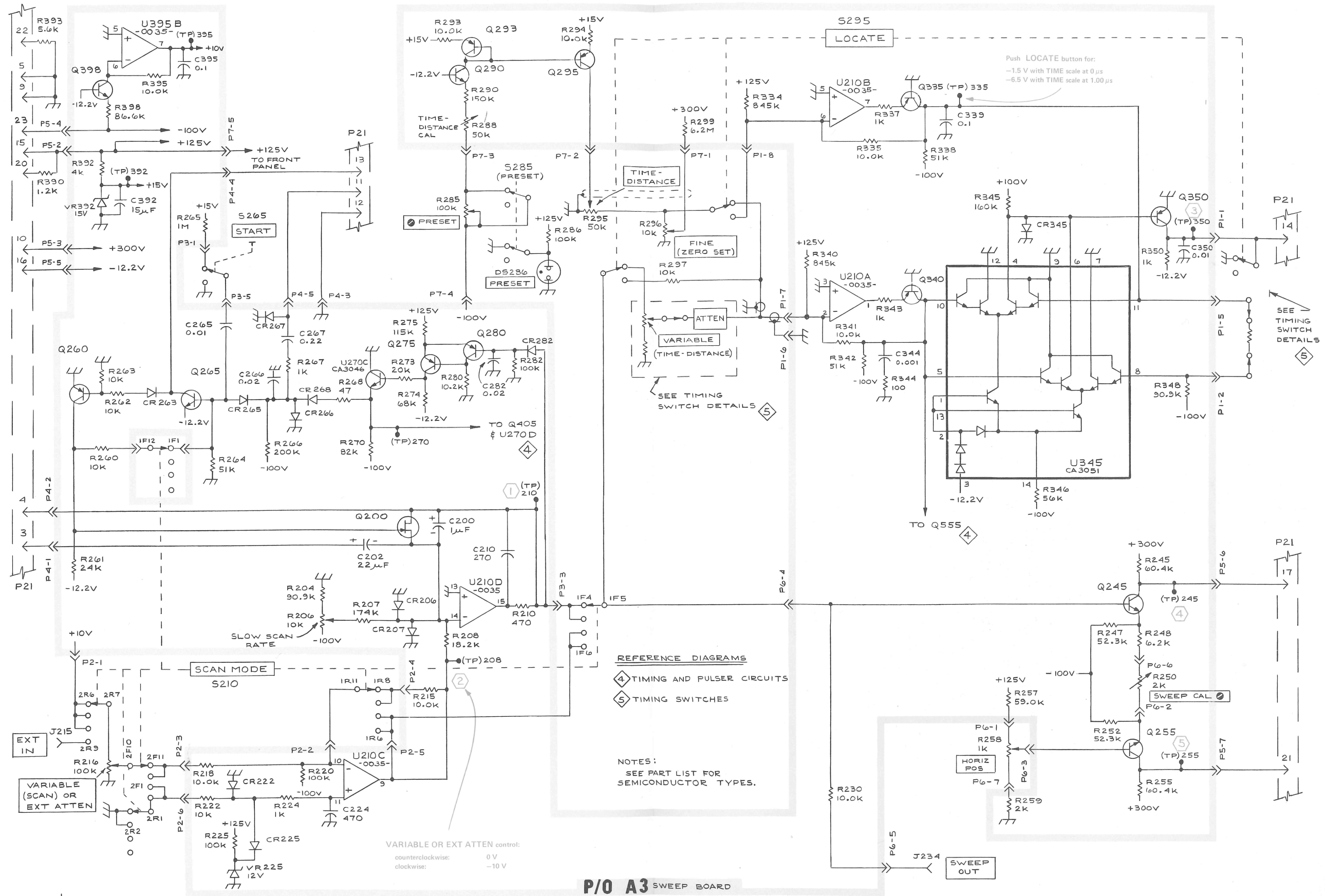

REFERENCE DIAGRAMS
 4 TIMING AND PULSER CIRCUITS
 5 TIMING SWITCHES

NOTES:
 SEE PART LIST FOR SEMICONDUCTOR TYPES.

VARIABLE OR EXT ATTEN control:
 counterclockwise: 0V
 clockwise: -10V

P/O A3 SWEEP BOARD

3T7

SLOW RAMP & OUTPUT AMPLIFIER

0171 EEB

3T7 SLOW RAMP GENERATOR AND OUTPUT AMPLIFIER

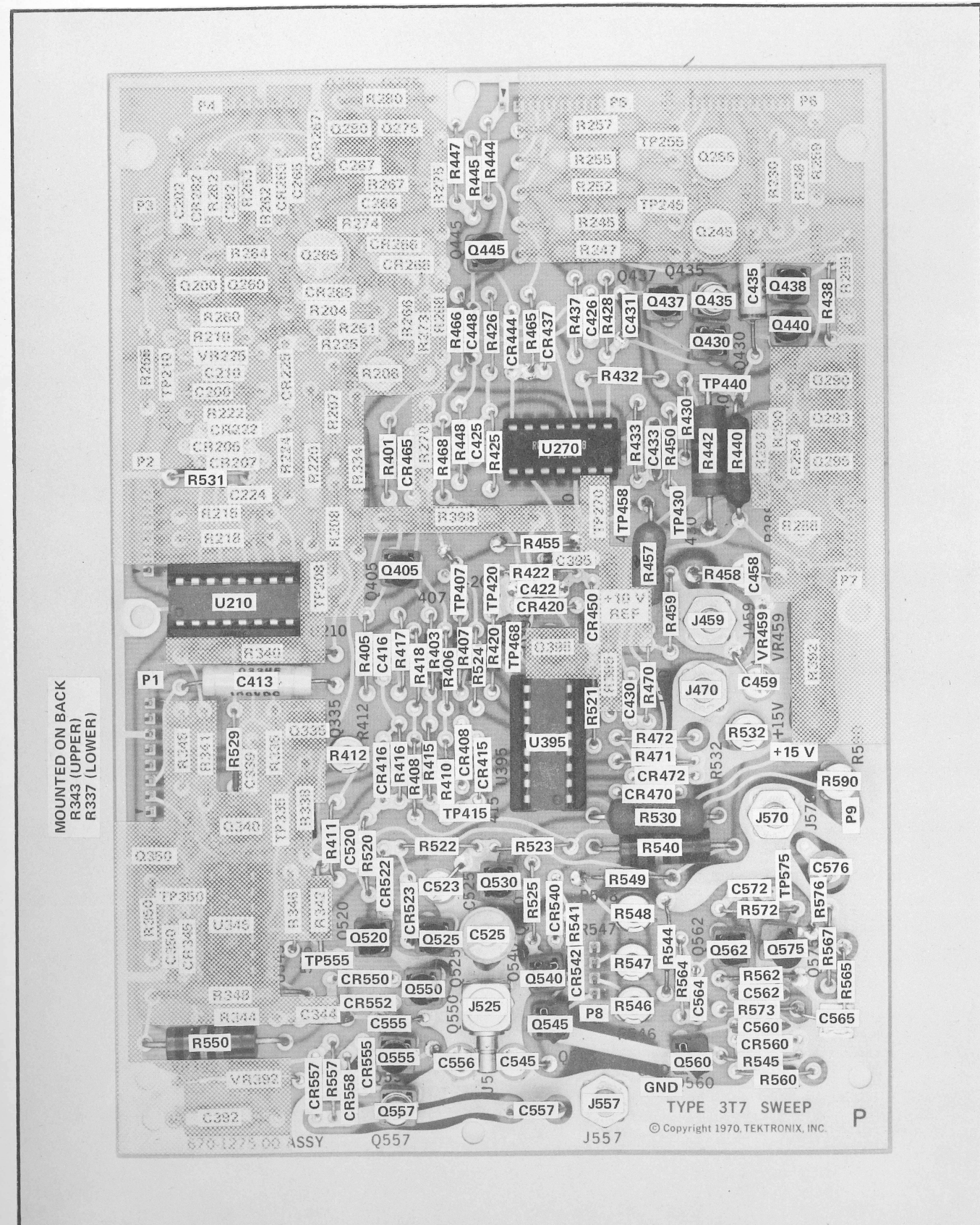

A3 Sweep Circuit Board

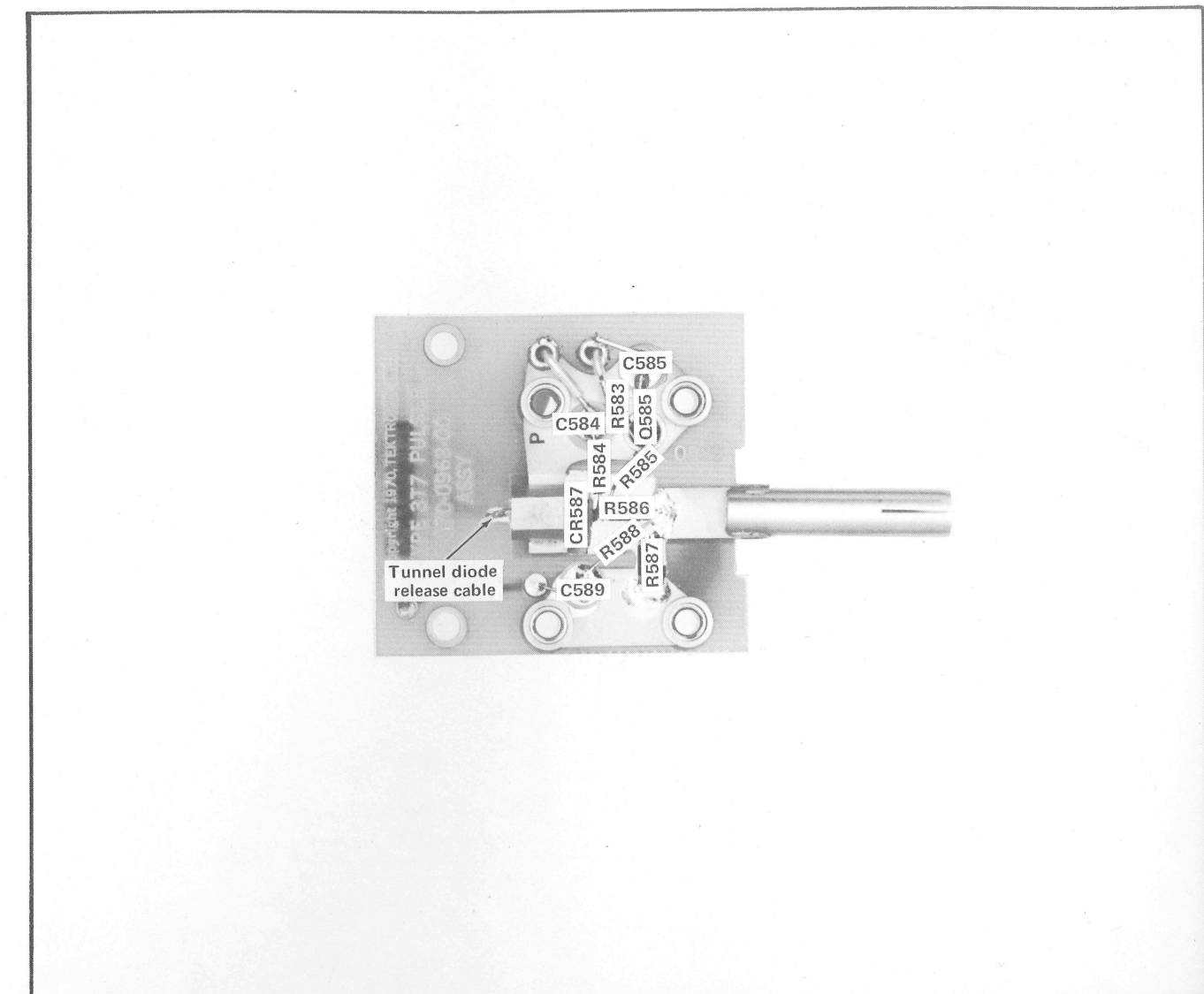

A4 Pulser circuit board

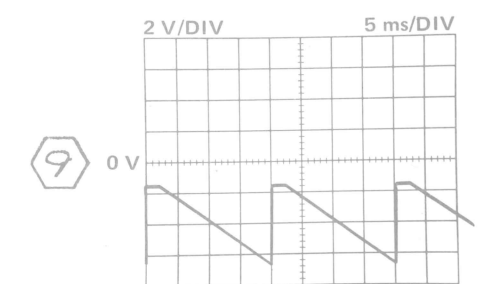
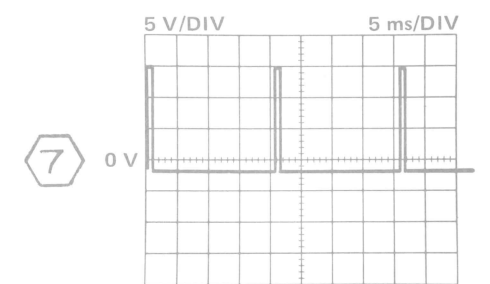
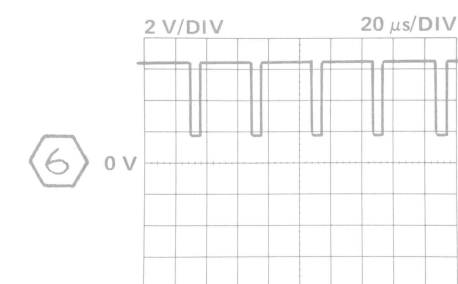
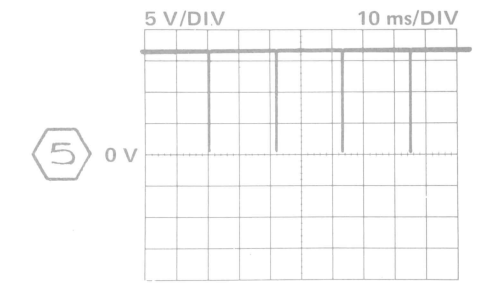
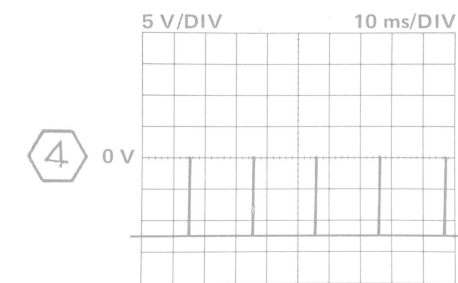
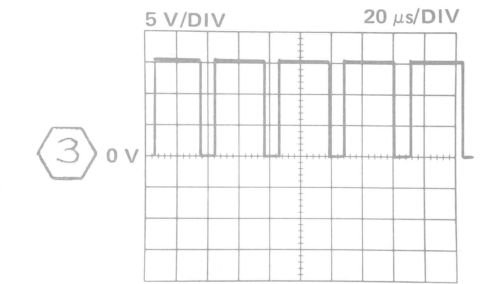
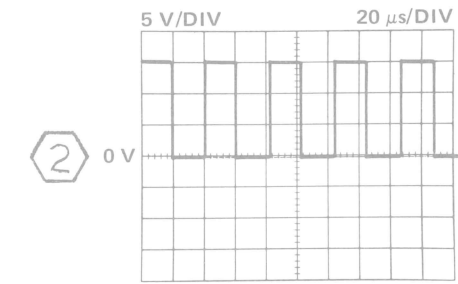
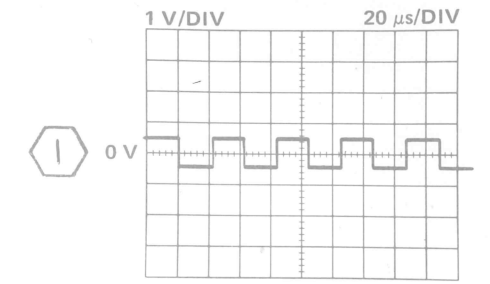
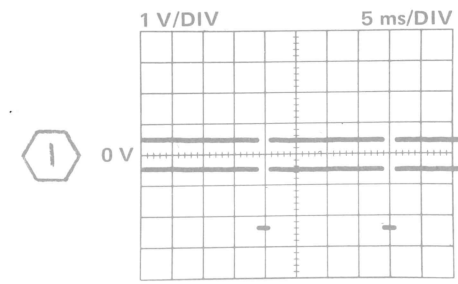

VOLTAGE and WAVEFORM conditions given on page 8-4

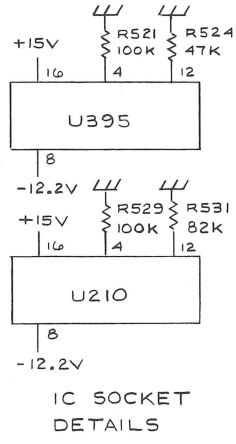
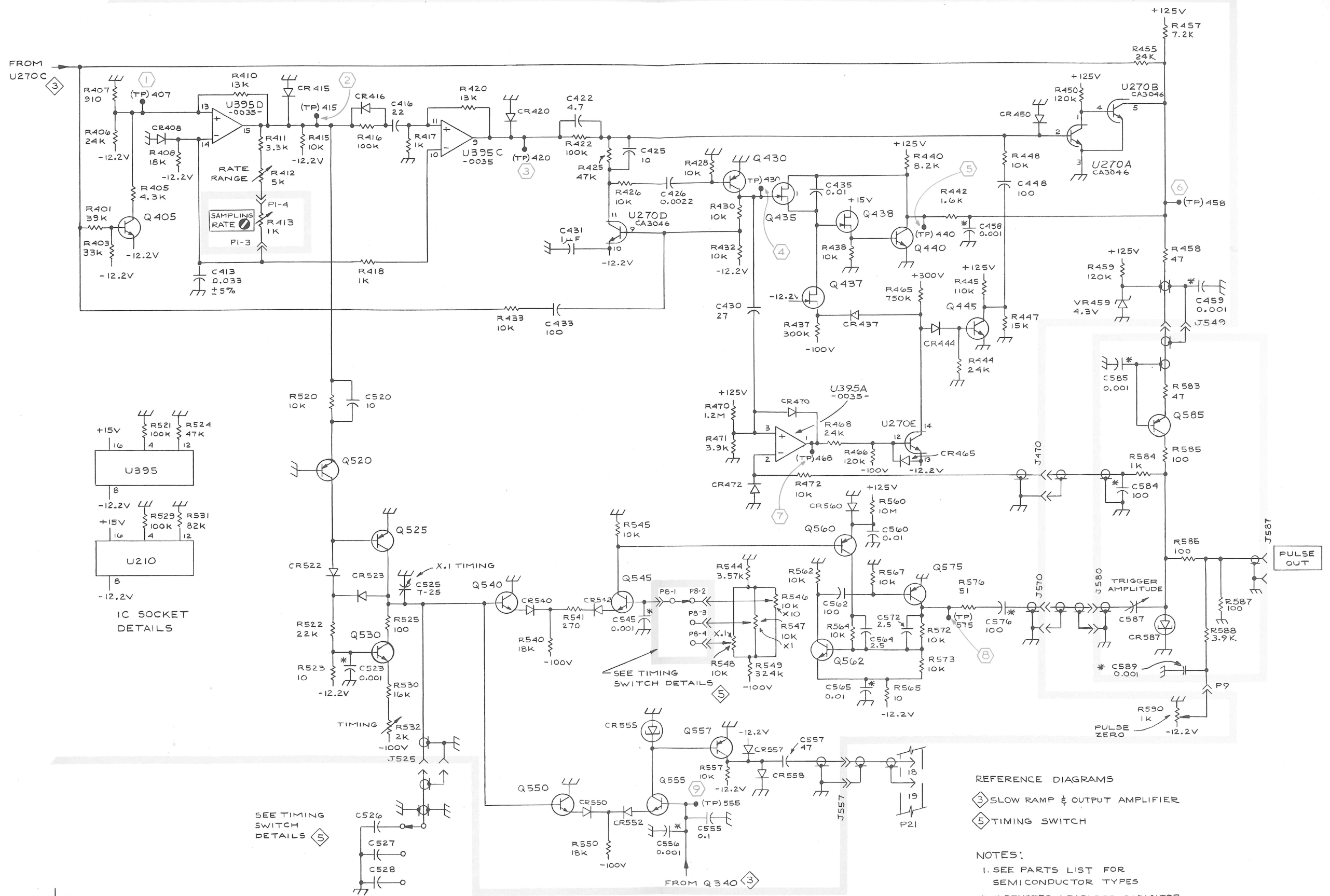

REFERENCE DIAGRAMS
 ⓓ SLOW RAMP & OUTPUT AMPLIFIER
 ⓔ TIMING SWITCH

NOTES:
 1. SEE PARTS LIST FOR SEMICONDUCTOR TYPES
 2. * DENOTES LEADLESS CAPACITOR

TIMING AND PULSER CIRCUITS ⓔ

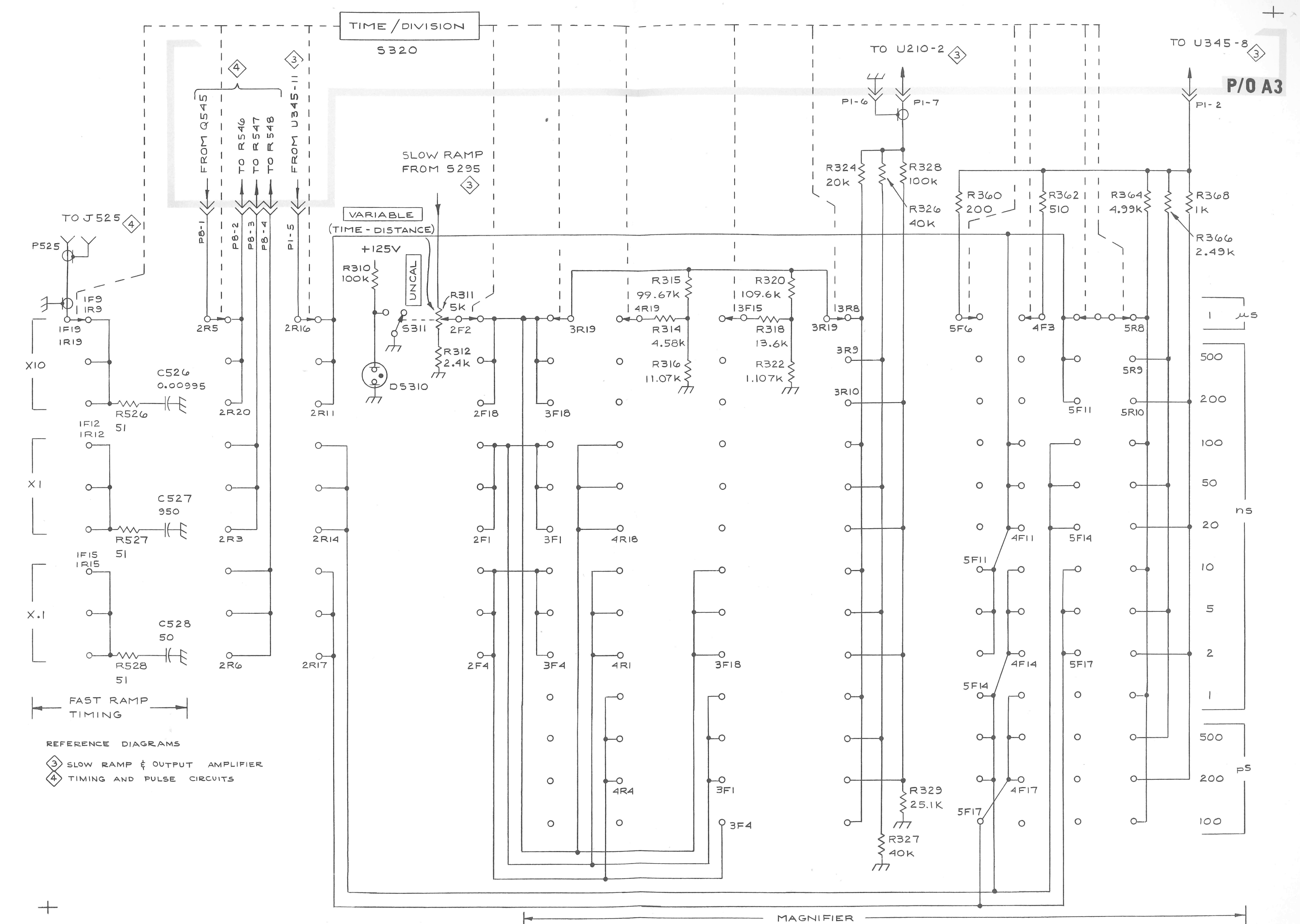

FIGURE AND INDEX NUMBERS

Items in this section are referenced by figure and index numbers to the illustrations which appear either on the back of the diagrams or on pullout pages immediately following the diagrams of the instruction manual.

INDENTATION SYSTEM

This mechanical parts list is indented to indicated item relationships. Following is an example of the indentation system used in the Description column.

Assembly and/or Component
Detail Part of Assembly and/or Component
mounting hardware for Detail Part
Parts of Detail Part
mounting hardware for Parts of Detail Part
mounting hardware for Assembly and/or Component

Mounting hardware always appears in the same indentation as the item it mounts, while the detail parts are indented to the right. Indented items are part of, and included with, the next higher indentation.

Mounting hardware must be purchased separately, unless otherwise specified.

PARTS ORDERING INFORMATION

Replacement parts are available from or through your local Tektronix, Inc. Field Office or representative.

Changes to Tektronix instruments are sometimes made to accommodate improved components as they become available, and to give you the benefit of the latest circuit improvements developed in our engineering department. It is therefore important, when ordering parts, to include the following information in your order: Part number, instrument type or number, serial or model number, and modification number if applicable.

If a part you have ordered has been replaced with a new or improved part, your local Tektronix, Inc. Field Office or representative will contact you concerning any change in part number.

Change information, if any, is located at the rear of this manual.

ABBREVIATIONS AND SYMBOLS

For an explanation of the abbreviations and symbols used in this section, please refer to the page immediately preceding the Electrical Parts List in this instruction manual.

SECTION 9 MECHANICAL PARTS LIST

FIGURE 1 EXPLODED 3S7

INDEX OF MECHANICAL PARTS LIST & ILLUSTRATIONS

Title	Page Nos. of Parts List
Figure 1 Exploded 3S7	9-1 thru 9-4
Figure 2 Exploded 3T7	9-5 thru 9-10
Figure 3 Standard Accessories	(parts list combined with illustration)
Figure 4 Repackaging	(parts list combined with illustration)

Fig. & Index No.	Tektronix Part No.	Serial/Model No. Eff	No. Disc	Q					Description	
				Y	1	2	3	4		5
1-1	366-0189-00			1					1	KNOB, red—VARIABLE CAL
	213-0020-00			-					-	knob includes:
	213-0020-00			1					1	SETSCREW, 6-32 x 0.125 inch, HSS
-2	366-0322-00			1					1	KNOB, charcoal—UNITS/DIV
	213-0004-00			-					-	knob includes:
	213-0004-00			1					1	SETSCREW, 6-32 x 0.188 inch, HSS
-3	366-0265-00			1					1	KNOB, red—FINE
	213-0022-00			-					-	knob includes:
	213-0022-00			1					1	SETSCREW, 4-40 x 0.188 inch, HSS
-4	366-1270-00			1					1	KNOB, charcoal—DC OFFSET
	213-0004-00			-					-	knob includes:
	213-0004-00			1					1	SETSCREW, 6-32 x 0.188 inch, HSS
-5	366-0109-00			1					1	KNOB, plug-in securing
	213-0005-00			-					-	knob includes:
	213-0005-00			1					1	SETSCREW, 8-32 x 0.125 inch, HSS
-6	136-0140-00			1					1	SOCKET, banana jack
	210-0465-00			-					-	mounting hardware: <i>(not included w/socket)</i>
	210-0465-00			2					2	NUT, hex., 0.25-32 x 0.375 inch
	210-0223-00			1					1	LUG, solder, 0.25 inch, SE
	210-0895-00			1					1	WASHER, plastic, shouldered, 0.375 inch OD
-10	262-0912-00			1					1	SWITCH, rotary—UNITS/DIV, wired
	260-1192-00			-					-	switch includes:
	260-1192-00			1					1	SWITCH, rotary, unwired
-11				1					1	RESISTOR, variable
	210-0413-00			-					-	mounting hardware: <i>(not included w/resistor)</i>
	210-0413-00			2					2	NUT, hex., 0.375-32 x 0.50 inch
-12	210-0413-00			1					1	WASHER, lock, internal, 0.375 ID x 0.638 inch OD
-13	210-0012-00									
-14	376-0014-00			1					1	COUPLING, variable resistor
-15	384-0353-00			1					1	ROD, shaft extension, 2.782 inches long
	210-0590-00			-					-	mounting hardware: <i>(not included w/switch)</i>
	210-0590-00			1					1	NUT, hex., 0.375-32 x 0.438 inch
-17	210-0978-00			1					1	WASHER, flat, 0.375 ID x 0.50 inch OD
-18	210-0012-00			1					1	WASHER, lock, internal, 0.375 ID x 0.638 inch OD
	132-0139-00			2					2	CONNECTOR, receptacle, electrical
	132-0002-00			-					-	each connector includes:
	132-0002-00			1					1	SLEEVE, outer conductor
-20	132-0029-00			1					1	CONDUCTOR, inner
-21	132-0028-00			1					1	INSULATOR, plastic
-22	103-0055-00			1					1	ADAPTER, inner conductor to section line

FIGURE 1 EXPLODED 3S7 (cont)

Fig. & Index No.	Tektronix Part No.	Serial/Model No. Eff	No. Disc	Q					Description
				y	1	2	3	4	
1-23	132-0007-00			2					RING, snap
-24	205-0062-00			1					SHELL, connector
-25	214-0700-00			1					COUPLER
-26	220-0460-00			1					NUT, coupling
-27	103-0054-00			1					ADAPTER, section line
-28	220-0459-00			1					mounting hardware for each: (not included w/connector) NUT, dodecagon, 0.875-32 x 1 inch
-29	119-0256-00			1					LINE SECTION, RF, top
-30	119-0257-00			1					LINE SECTION, RF, bottom
-31	211-0014-00			13					SCREW, 4-40 x 0.50 inch, PHS
-32	210-0586-00			13					NUT, keps, 4-40 x 0.25 inch, PHS
-33	670-0964-00			1					CIRCUIT BOARD ASSEMBLY—VERTICAL A1
	388-1758-00			-					circuit board assembly includes:
-34	131-0608-00			1					CIRCUIT BOARD
-35	136-0220-00			27					TERMINAL, pin, 0.365 inch long
-36	214-0579-00			6					SOCKET, transistor, 3 pin, square
-37	131-0391-00			7					PIN, test point
-38	136-0183-00			1					CONNECTOR, receptacle, snap-on male
	210-0709-00			2					SOCKET, transistor, 3 pin
-39	136-0252-00			13					EYELET, 0.138 OD x 0.27 inch long (not shown)
-40	214-0697-00			3					SOCKET, pin connector, 0.145 inch long
	344-0212-00			2					CONTACT, electrical
-41	136-0260-01			2					CLIP, electrical, diode (not shown)
	361-0130-00			1					SOCKET, integrated circuit, 16 pin
-42	211-0116-00			26					SPACER, sleeve, 0.25 OD x 0.125 inch long
				-					mounting hardware: (not included w/circuit board assembly)
				2					SCREW, sems, 4-40 x 0.312 inch, PHB
-43	384-0531-00			2					ROD, plastic
-44	211-0008-00			1					SCREW, 4-40 x 0.25 inch, PHS
-45	333-1360-00			1					PANEL, front
-46	260-0449-00			1					SWITCH, slide—UNITS
-47	210-0406-00			2					NUT, hex., 4-40 x 0.188 inch
-48	210-0054-00			2					WASHER, lock, split, 0.118 ID x 0.212 inch OD
-49	260-0969-00			1					SWITCH, slide—RESOLUTION
-50	210-0406-00			2					NUT, hex., 4-40 x 0.188 inch
-51	210-0054-00			2					WASHER, lock, split, 0.118 ID x 0.212 inch OD

FIGURE 1 EXPLODED 3S7 (cont)

Fig. & Index No.	Tektronix Part No.	Serial/Model No. Eff	No. Disc	Q					Description
				y	1	2	3	4	
1-52	260-0447-00			1					SWITCH, slide—POLARITY
-53	210-0406-00			-					mounting hardware: (not included w/switch)
-54	210-0054-00			2					NUT, hex., 4-40 x 0.188 inch
-55				2					RESISTOR, variable
-56	358-0422-00			-					mounting hardware for each: (not included w/resistor)
-57	210-0583-00			1					BUSHING, 0.25-32 x 0.188 inch long
-58	220-0510-00			1					NUT, hex., 0.25-32 x 0.312 inch
-59				1					RESISTOR, variable
-60	210-0583-00			-					mounting hardware: (not included w/resistor)
-61	210-0940-00			1					NUT, hex., 0.25-32 x 0.312 inch
-62	210-0223-01			1					WASHER, flat, 0.25 ID x 0.375 inch OD
-63	352-0064-01			1					LUG, solder, 0.25 inch, SE, bent
-64	211-0109-00			1					HOLDER, neon, double
-65	210-0406-00			-					mounting hardware: (not included w/holder)
-66	378-0541-00			1					SCREW, 4-40 x 0.875 inch 100° csk, FHS
-67	352-0084-00			1					NUT, hex., 4-40 x 0.188 inch
-68	200-0609-00			3					FILTER, lens
-69	358-0378-00			1					HOLDER, neon, single
-70	670-0143-00			1					CAP, lamp holder
-71	388-0842-00			2					BUSHING, sleeve, front panel trim
-72	136-0252-00			1					CIRCUIT BOARD ASSEMBLY—POSITION INDICATOR A2
-73	384-0615-00			-					circuit board assembly includes:
	212-0023-00			1					CIRCUIT BOARD
-74	214-0052-00			6					SOCKET, pin connector, 0.145 inch long
-75	210-0406-00			4					ROD, spacer, plug-in
-76	210-0054-00			-					mounting hardware for each: (not included w/rod)
				1					SCREW, 8-32 x 0.375 inch, PHS
				1					FASTENER
				-					mounting hardware: (not included w/fastener)
				2					NUT, hex., 4-40 x 0.188 inch
				2					WASHER, lock, split, 0.118 ID x 0.212 inch OD

FIGURE 1 EXPLODED 357 (cont)

Fig. & Index No.	Tektronix Part No.	Serial/Model No. Eff Disc	Q					Description	
			f	y	1	2	3		4
1-77	386-1863-00		1						SUBPANEL, front
-78	441-0966-00		1						CHASSIS
			-						mounting hardware: <i>(not included w/chassis)</i>
-79	211-0538-00		2						SCREW, 6-32 x 0.312 inch, 100° csk, FHS
-80	210-0457-00		1						NUT, keps, 6-32 x 0.312 inch
-81	211-0504-00		2						SCREW, 6-32 x 0.25 inch, PHS
-82	131-0149-00		1						CONNECTOR, receptacle, 24 contact
			-						mounting hardware: <i>(not included w/connector)</i>
-83	211-0097-00		2						SCREW, 4-40 x 0.312 inch, PHS
-84	210-0201-00		2						LUG, solder, SE #4
-85	210-0586-00		2						NUT, keps, 4-40 x 0.25 inch
-86	351-0037-00		1						GUIDE SHOE, plastic
			-						mounting hardware: <i>(not included w/guide shoe)</i>
-87	211-0013-00		1						SCREW, 4-40 x 0.375 inch, RHS
-88	210-0586-00		1						NUT, keps, 4-40 x 0.25 inch
-89	386-1864-00		1						PANEL, rear
-90	179-1595-00		1						WIRING HARNESS, main
			-						wiring harness includes:
-91	131-0707-00		20						CONNECTOR, terminal
-92	352-0162-03		1						HOLDER, terminal connector, 4 wire <i>(orange)</i>
-93	352-0165-02		1						HOLDER, terminal connector, 7 wire <i>(red)</i>
-94	352-0167-01		1						HOLDER, terminal connector, 9 wire <i>(brown)</i>
	179-1596-00		1						WIRING HARNESS, connector
			-						wiring harness includes:
	131-0707-00		7						CONNECTOR, terminal
	352-0165-04		1						HOLDER, terminal connector, 7 wire <i>(yellow)</i>
-95	131-0375-00		1						CONNECTOR, right angle
-96	348-0051-00		1						GROMMET, rubber, 0.75 ID x 1.125 inches OD
-97	200-0534-00		1						COVER, neon, holder, double

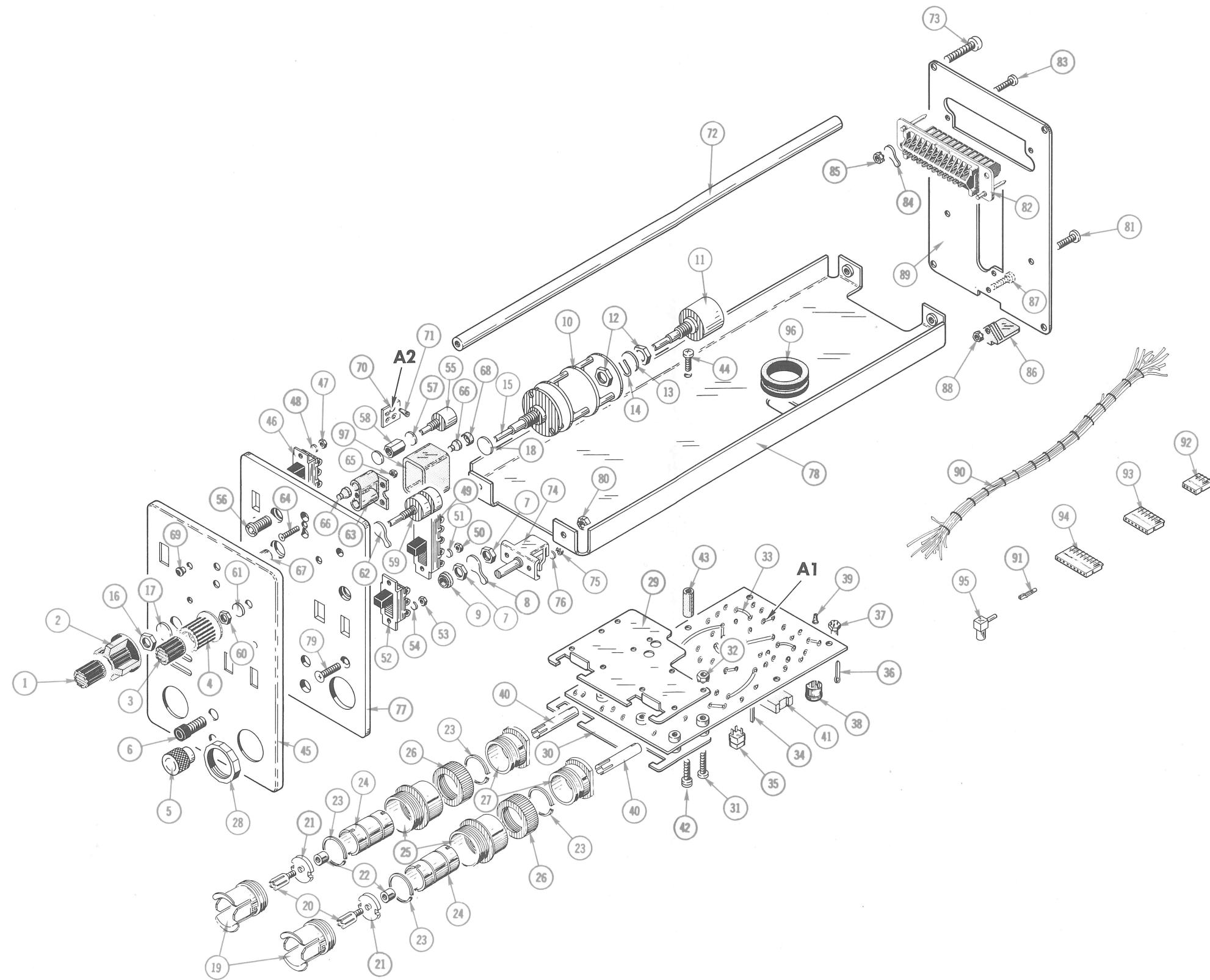

+[Ⓐ]

+

FIG. 2 EXPLODED 3T7

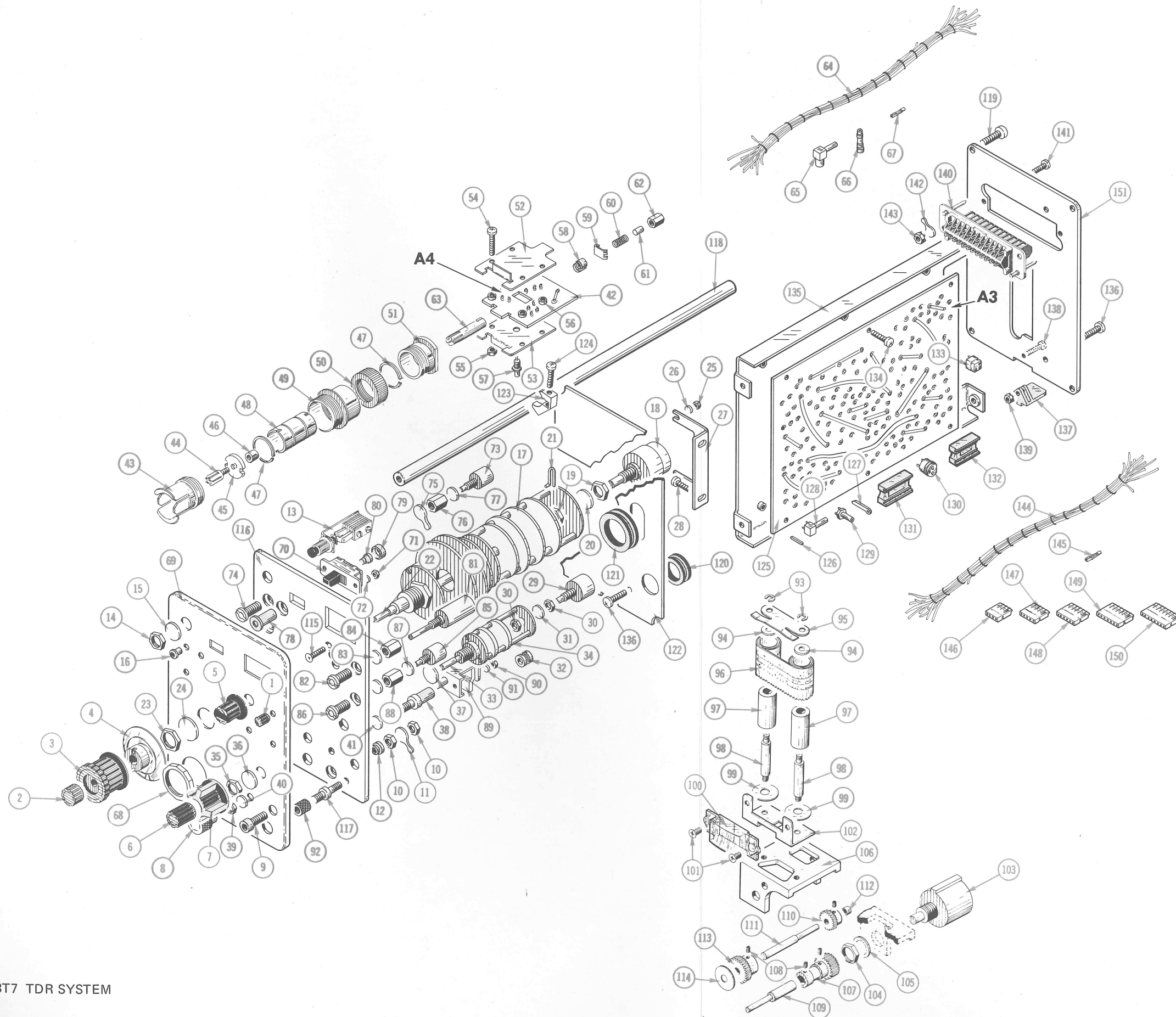

+

FIGURE 2 EXPLODED 3T7

Fig. & Index No.	Tektronix Part No.	Serial/Model Eff	No. Disc	Q					Description	
				t	y	1	2	3		4
2-1	366-1173-01			1						1 KNOB, charcoal—FINE
-2	366-0038-00			1						1 KNOB, red—VARIABLE CAL
				-						knob includes:
	213-0004-00			1						1 SETSCREW, 6-32 x 0.188 inch, HSS
-3	366-0318-00			1						1 KNOB, charcoal—TIME/DIV
				-						knob includes:
	213-0022-00			2						2 SETSCREW, 4-40 x 0.188 inch, HSS
-4	331-0155-00			1						1 DIAL—TIME-DISTANCE
				-						dial includes:
	213-0022-00			2						2 SETSCREW, 4-40 x 0.188 inch, HSS
-5	366-0487-00			1						1 KNOB, charcoal crank—TIME-DISTANCE
				-						knob includes:
	213-0153-00			2						2 SETSCREW, 5-40 x 0.125 inch, HSS
-6	366-0189-00			1						1 KNOB, red—VARIABLE or EXT ATTEN
				-						knob includes:
	213-0020-00			1						1 SETSCREW, 6-32 x 0.125 inch, HSS
-7	366-0322-00			1						1 KNOB, charcoal—SCAN MODE
				-						knob includes:
	213-0004-00			1						1 SETSCREW, 6-32 x 0.188 inch, HSS
-8	366-0109-00			1						1 KNOB, plug-in securing
				-						knob includes:
	213-0005-00			1						1 SETSCREW, 8-32 x 0.125 inch, HSS
-9	136-0140-00			2						2 SOCKET, banana jack
				-						mounting hardware for each: (not included w/socket)
-10	210-0465-00			2						2 NUT, hex., 0.25-32 x 0.375 inch
-11	210-0223-00			1						1 LUG, solder, 0.25 inch SE
-12	210-0895-00			1						1 WASHER, plastic, shouldered 0.375 inch OD
-13	260-1203-00			1						1 SWITCH, pushbutton—LOCATE
				-						mounting hardware: (not included w/switch)
-14	210-0590-00			1						1 NUT, hex., 0.375-32 x 0.438 inch
-15	210-0978-00			1						1 WASHER, flat, 0.375 ID x 0.50 inch OD
-16	358-0378-00			4						4 BUSHING, sleeve, front panel trim
-17	262-0911-00			1						1 SWITCH, rotary—TIME-DISTANCE & TIME/DIV
				-						switch includes:
	260-1194-00			1						1 SWITCH, rotary, unwired
-18				1						1 RESISTOR, variable
				-						mounting hardware: (not included w/resistor)
-19	210-0413-00			2						2 NUT, hex., 0.375-32 x 0.50 inch
-20	210-0012-00			1						1 WASHER, lock, internal, 0.375 ID x 0.50 inch OD
-21	376-0014-00			1						1 COUPLING, variable resistor
-22	384-0147-00			1						1 ROD, shaft extension, 5.938 inches long

FIGURE 2 EXPLODED 3T7 (cont)

Fig. & Index No.	Tektronix Part No.	Serial/Model No. Eff	No. Disc	Q					Description
				t	y	1	2	3	
-	-	-	-	-	-	-	-	-	mounting hardware: (not included w/switch)
2-23	210-0579-00	-	-	1	-	-	-	-	NUT, hex., 0.625-24 x 0.75 inch
-24	210-1010-00	-	-	1	-	-	-	-	WASHER, flat, 0.643 ID x 0.875 inch OD
-25	210-0449-00	-	-	2	-	-	-	-	NUT, hex., 5-40 x 0.25 inch
-26	210-0017-00	-	-	2	-	-	-	-	WASHER, lock, split, 0.125 ID x 0.235 inch OD
-27	407-0853-00	-	-	1	-	-	-	-	BRACKET, rotary switch
-28	211-0504-00	-	-	2	-	-	-	-	SCREW, 6-32 x 0.25 inch, PHS
-29	-	-	-	1	-	-	-	-	RESISTOR, variable
-	-	-	-	-	-	-	-	-	mounting hardware: (not included w/resistor)
-30	210-0583-00	-	-	2	-	-	-	-	NUT, hex., 0.25-32 x 0.312 inch
-31	210-0046-00	-	-	1	-	-	-	-	WASHER, lock, internal, 0.261 ID x 0.40 inch OD
-32	376-0050-00	-	-	1	-	-	-	-	COUPLING, flexible
-	-	-	-	-	-	-	-	-	coupling includes:
-	213-0022-00	-	-	4	-	-	-	-	SETSCREW, 4-40 x 0.188 inch, HSS
-33	384-0418-00	-	-	1	-	-	-	-	EXTENSION SHAFT, 2.75 inches long
-34	260-1193-00	-	-	1	-	-	-	-	SWITCH, rotary—SCAN MODE, unwired
-	-	-	-	-	-	-	-	-	mounting hardware: (not included w/switch)
-35	210-0590-00	-	-	1	-	-	-	-	NUT, hex., 0.375-32 x 0.438 inch
-36	210-0978-00	-	-	1	-	-	-	-	WASHER, flat, 0.375 ID x 0.50 inch OD
-37	210-0012-00	-	-	1	-	-	-	-	WASHER, lock, internal, 0.375 ID x 0.50 inch OD
-38	260-0689-00	-	-	1	-	-	-	-	SWITCH, pushbutton—START
-	-	-	-	-	-	-	-	-	mounting hardware: (not included w/switch)
-39	210-0583-00	-	-	1	-	-	-	-	NUT, hex., 0.25-32 x 0.312 inch
-40	210-0940-00	-	-	1	-	-	-	-	WASHER, flat, 0.25 ID x 0.375 inch OD
-41	210-0046-00	-	-	1	-	-	-	-	WASHER, lock, internal, 0.261 ID x 0.40 inch OD
-42	670-0963-00	-	-	1	-	-	-	-	CIRCUIT BOARD ASSEMBLY—PULSER A4
-	-	-	-	-	-	-	-	-	circuit board assembly includes:
-	388-1757-00	-	-	1	-	-	-	-	CIRCUIT BOARD
-	132-0145-00	-	-	1	-	-	-	-	CONNECTOR, receptacle, electrical
-	-	-	-	-	-	-	-	-	connector includes:
-43	132-0002-00	-	-	1	-	-	-	-	SLEEVE, outer conductor
-44	132-0029-00	-	-	1	-	-	-	-	CONDUCTOR, inner
-45	132-0028-00	-	-	1	-	-	-	-	INSULATOR, plastic
-46	103-0055-00	-	-	1	-	-	-	-	ADAPTER, inner conductor to section line
-47	132-0007-00	-	-	2	-	-	-	-	RING, snap
-48	205-0136-00	-	-	1	-	-	-	-	SHELL, connector
-49	214-0700-00	-	-	1	-	-	-	-	COUPLER
-50	220-0460-00	-	-	1	-	-	-	-	NUT, coupling
-51	103-0054-00	-	-	1	-	-	-	-	ADAPTER, section line
-52	119-0067-00	-	-	1	-	-	-	-	LINE SECTION, RF
-53	119-0067-03	-	-	1	-	-	-	-	LINE SECTION, RF
-	-	-	-	-	-	-	-	-	mounting hardware: (not included w/line section)
-54	211-0014-00	-	-	4	-	-	-	-	SCREW, 4-40 x 0.50 inch, PHS
-55	210-0586-00	-	-	4	-	-	-	-	NUT, keps, 4-40 x 0.25 inch

FIGURE 2 EXPLODED 3T7 (cont)

Fig. & Index No.	Tektronix Part No.	Serial/Model No. Eff	No. Disc	Q					Description
				t	y	1	2	3	
2-56	361-0130-00	-	-	8	-	-	-	-	SPACER, sleeve, 0.25 OD x 0.27 inch long
-	210-0709-00	-	-	4	-	-	-	-	EYELET, 0.138 OD x 0.27 inch long (not shown)
-	210-0629-00	-	-	2	-	-	-	-	EYELET, 0.059 OD x 0.093 inch long (not shown)
-	210-0707-00	-	-	2	-	-	-	-	EYELET, 0.089 inch diameter (not shown)
-57	131-0548-00	-	-	1	-	-	-	-	CONNECTOR, receptacle, coaxial, snap on
-58	352-0097-00	-	-	1	-	-	-	-	HOLDER, rod resistor
-59	-	-	-	1	-	-	-	-	DIODE, grounding spring assembly
-60	214-0259-00	-	-	1	-	-	-	-	SPRING, interlock pin, 0.312 inch long
-61	210-0676-00	-	-	1	-	-	-	-	EYELET, 0.089 OD x 0.281 inch long
-62	380-0103-00	-	-	1	-	-	-	-	HOUSING, helical spring
-63	214-0697-00	-	-	1	-	-	-	-	CONTACT, electrical, circuit board to GR
-64	179-1599-00	-	-	1	-	-	-	-	WIRING HARNESS
-	-	-	-	-	-	-	-	-	wiring harness includes:
-65	131-0375-00	-	-	1	-	-	-	-	CONNECTOR, right angle
-66	131-0155-00	-	-	3	-	-	-	-	CONNECTOR, coaxial
-67	131-0371-00	-	-	1	-	-	-	-	CONNECTOR, terminal
-	-	-	-	-	-	-	-	-	mounting hardware (not included w/circuit board assembly)
-68	220-0459-00	-	-	1	-	-	-	-	NUT, dodecagon, 0.875-32 x 1 inch
-69	333-1359-00	-	-	1	-	-	-	-	PANEL, front
-70	260-0447-00	-	-	1	-	-	-	-	SWITCH, slide—PRESET
-	-	-	-	-	-	-	-	-	mounting hardware: (not included w/switch)
-71	210-0406-00	-	-	2	-	-	-	-	NUT, hex., 4-40 x 0.188 inch
-72	210-0054-00	-	-	2	-	-	-	-	WASHER, lock, split, 0.118 ID x 0.212 inch OD
-73	-	-	-	1	-	-	-	-	RESISTOR, variable
-	-	-	-	-	-	-	-	-	mounting hardware: (not included w/resistor)
-74	358-0422-00	-	-	1	-	-	-	-	BUSHING, 0.25-32 x 0.159 ID x 0.188 inch long
-75	210-0223-00	-	-	1	-	-	-	-	LUG, solder, 0.25 inch, SE
-76	220-0510-00	-	-	1	-	-	-	-	NUT, hex., 0.25-32 x 0.25 inch
-77	210-0583-00	-	-	1	-	-	-	-	NUT, hex., 0.25-32 x 0.312 inch
-78	352-0084-00	-	-	2	-	-	-	-	HOLDER, neon, single
-79	200-0609-00	-	-	2	-	-	-	-	CAP, lamp holder
-80	378-0541-00	-	-	2	-	-	-	-	FILTER, lens
-81	-	-	-	1	-	-	-	-	RESISTOR, variable
-	-	-	-	-	-	-	-	-	mounting hardware: (not included w/resistor)
82	358-0422-00	-	-	1	-	-	-	-	BUSHING, 0.25-32 x 0.159 ID x 0.188 inch long
-83	210-0583-00	-	-	1	-	-	-	-	NUT, hex., 0.25-32 x 0.312 inch
-84	220-0510-00	-	-	1	-	-	-	-	NUT, hex., 0.25-32 x 0.25 inch
-85	-	-	-	3	-	-	-	-	RESISTOR, variable
-	-	-	-	-	-	-	-	-	mounting hardware for each: (not included w/resistor)
-86	358-0422-00	-	-	1	-	-	-	-	BUSHING, 0.25-32 x 0.158 ID x 0.188 inch long
-87	210-0583-00	-	-	1	-	-	-	-	NUT, hex., 0.25-32 x 0.312 inch
-88	220-0510-00	-	-	1	-	-	-	-	NUT, hex., 0.25-32 x 0.25 inch

FIGURE 2 EXPLODED 3T7 (cont)

Fig. & Index No.	Tektronix Part No.	Serial/Model Eff	No. Disc	Q					Description
				y	1	2	3	4	
2-89	214-0052-00			1					FASTENER
				-					mounting hardware: <i>(not included w/fastener)</i>
-90	210-0406-00			2					NUT, hex., 4-40 x 0.188 inch
-91	210-0054-00			2					WASHER, lock, split, 0.118 ID x 0.212 inch OD
-92	200-0103-00			1					CAP, ground post
	331-0275-00			1					DIAL ASSEMBLY, tape
				-					dial assembly includes:
-93	354-0163-00			2					RING, retaining
-94	210-0803-00			2					WASHER, flat, 0.15 ID x 0.375 inch OD
-95	386-1299-00			1					PLATE, retaining
-96	331-0273-00			1					DIAL TAPE
-97	401-0042-00			2					BEARING, sleeve
-98	129-0288-00			2					POST, dial tape spool
-99	210-1043-00			2					WASHER, plastic, 0.245 ID x 0.685 inch OD
-100	331-0189-00			1					LENS, tape dial
				-					mounting hardware: <i>(not included w/lens)</i>
-101	211-0105-00			2					SCREW, 4-40 x 0.188 inch, 100° csk, FHS
-102	407-0861-00			1					BRACKET, angle
-103				1					RESISTOR, variable
				-					mounting hardware: <i>(not included w/resistor)</i>
-104	210-0413-00			1					NUT, hex., 0.375-32 x 0.50 inch
-105	210-0012-00			1					WASHER, lock, internal, 0.375 ID x 0.50 inch OD
-106	407-0843-00			1					BRACKET, readout
-107	214-0953-00			1					GEAR, spur
-108	213-0075-00			6					SETSCREW, 4-40 x 0.094 inch, HSS
-109	384-1040-00			1					SHAFT, extension
-110	401-0105-00			1					GEAR, spur
-111	384-1039-00			1					SHAFT, extension
-112	166-0024-00			1					SPACER
-113	401-0106-00			1					GEAR, spur
-114	210-0917-00			1					WASHER, plastic, 0.191 ID x 0.625 inch OD
				-					mounting hardware: <i>(not included w/dial assembly)</i>
-115	211-0538-00			2					SCREW, 6-32 x 0.312 inch, 100° csk, FHS
-116	386-1862-00			1					SUBPANEL, front
				-					subpanel includes:
-117	355-0059-00			1					POST, binding
-118	384-0615-00			4					ROD, spacer, plug-in
				-					mounting hardware for each: <i>(not included w/rod)</i>
-119	212-0023-00			1					SCREW, 8-32 x 0.375 inch, PHS
-120	348-0012-00			1					GROMMET, rubber, 0.625 inch diameter
-121	348-0051-00			1					GROMMET, rubber, 0.75 inch diameter

FIGURE 2 EXPLODED 3T7 (cont)

Fig. & Index No.	Tektronix Part No.	Serial/Model Eff	No. Disc	Q					Description
				y	1	2	3	4	
2-122	386-1867-00			1					SUPPORT, plug-in unit
				-					support includes:
-123	343-0093-00			4					CLAMP, plug-in rod
-124	211-0094-00			4					SCREW, 4-40 x 0.50 inch, THS
-125	670-1275-00			1					CIRCUIT BOARD ASSEMBLY—SWEEP A3
				-					circuit board assembly includes:
	388-1787-00			1					CIRCUIT BOARD
-126	131-0608-00			47					TERMINAL, pin, 0.365 inch long
-127	214-0579-00			16					PIN, test point
	131-0633-00			1					TERMINAL, pin, 0.385 inch long
-128	131-0265-00			1					CONNECTOR, coaxial, right angle
-129	131-0391-00			4					CONNECTOR, receptacle, RF, snap-on
-130	136-0183-00			3					SOCKET, transistor, 3 pin
-131	136-0260-01			2					SOCKET, integrated circuit, 16 pin
-132	136-0269-00			2					SOCKET, integrated circuit, 14 pin
-133	136-0220-00			29					SOCKET, transistor, 3 pin, square
				-					mounting hardware: <i>(not included w/circuit board assembly)</i>
-134	211-0116-00			6					SCREW, sems, 4-40 x 0.312 inch, PHB
-135	441-0967-00			1					CHASSIS, main
				-					mounting hardware: <i>(not included w/chassis)</i>
-136	211-0504-00			4					SCREW, 6-32 x 0.25 inch, PHS
-137	351-0037-00			1					GUIDE, plug-in, plastic
				-					mounting hardware: <i>(not included w/guide)</i>
-138	211-0013-00			1					SCREW, 4-40 x 0.375 inch, RHS
-139	210-0586-00			1					NUT, keps, 4-40 x 0.25 inch
-140	131-0149-00			1					CONNECTOR, 24 contact, male
				-					mounting hardware: <i>(not included w/connector)</i>
-141	211-0097-00			2					SCREW, 4-40 x 0.312 inch, PHS
-142	210-0201-00			1					LUG, solder, SE #4
-143	210-0586-00			2					NUT, keps, 4-40 x 0.25 inch, PHS

FIGURE 2 EXPLODED 3T7 (cont)

Fig. & Index No.	Tektronix Part No.	Serial/Model No.		Q t y	Description
		Eff	Disc		
2-144	179-1597-00			1	WIRING HARNESS
-	-			-	wiring harness includes:
-145	131-0707-00			35	CONNECTOR, terminal
	131-0708-00			1	CONNECTOR, terminal
	131-0155-00			1	CONNECTOR
-146	352-0162-08			1	HOLDER, terminal connector, 4 wire (gray)
-147	352-0163-07			1	HOLDER, terminal connector, 5 wire (violet)
	352-0163-03			1	HOLDER, terminal connector, 5 wire (orange)
-148	352-0164-02			1	HOLDER, terminal connector, 6 wire (red)
-149	352-0165-06			1	HOLDER, terminal connector, 7 wire (blue)
-150	352-0166-01			1	HOLDER, terminal connector, 8 wire (brown)
	179-1598-00			1	WIRING HARNESS
-	-			-	wiring harness includes:
	131-0707-00			12	CONNECTOR, terminal
	352-0163-04			1	HOLDER, terminal connector, 5 wire (yellow)
	352-0165-05			1	HOLDER, terminal connector, 7 wire (green)
-151	386-1864-00			1	PANEL, rear

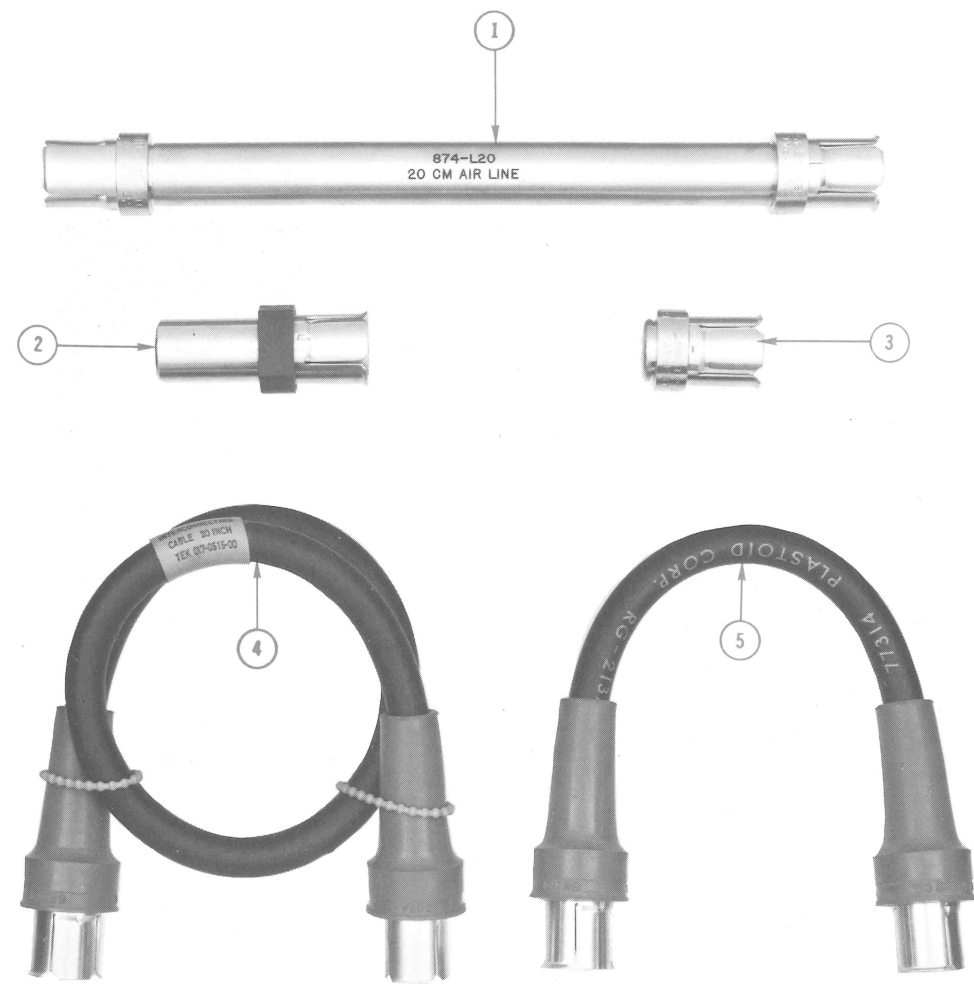

Ⓐ

Fig. & Index No.	Tektronix Part No.	Serial/Model No. Eff	No. Disc	Q					Description	
				†	y	1	2	3		4
INCLUDED w/3S7 ONLY										
3-1	017-0084-00				1					LINE, 50 Ω, 20 cm
-2	017-0081-00				1					TERMINATION, 50 Ω
-3	017-0087-00				1					TERMINATION, 50 Ω, short circuit
-4	017-0515-00				1					CABLE ASSEMBLY, RF, 20 inches long
-5	017-0513-00				1					CABLE ASSEMBLY, RF, 10 inches long
	062-1244-00				1					TDR CONCEPT BOOK (<i>not shown</i>)
	070-1092-00				1					MANUAL, instruction (<i>not shown</i>)
INCLUDED w/3T7 ONLY										
	070-1092-00				1					MANUAL, instruction (<i>not shown</i>)

⊕[Ⓐ]

CARTON ASSEMBLY
(Part No. 065-0119-00)

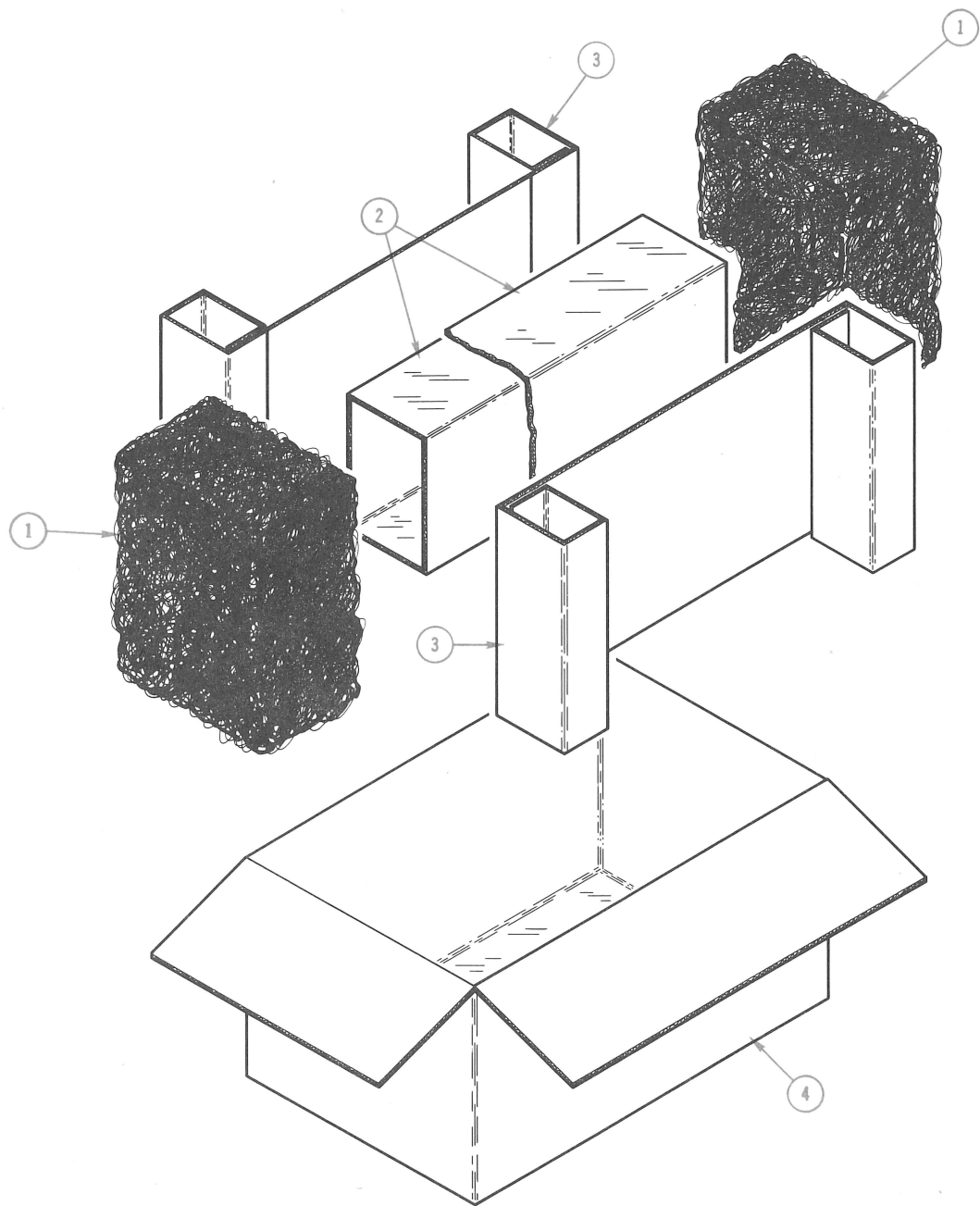

Fig. & Index No.	Tektronix Part No.	Serial/Model No. Eff	No. Disc	Q † y	Description					
					1	2	3	4	5	
4-	065-0119-00			2						CARTON ASSEMBLY for 3S7/3T7
	- - - - -			-						each carton assembly includes:
-1	004-0226-00			2						END CAP, molded hair-flex, w/inserts
-2	004-1037-00			1						SLEEVE SET, 2 piece
-3	004-1054-00			1						PAD SET, 2 piece
-4	004-0741-00			1						CARTON

MANUAL CHANGE INFORMATION

At Tektronix, we continually strive to keep up with latest electronic developments by adding circuit and component improvements to our instruments as soon as they are developed and tested.

Sometimes, due to printing and shipping requirements, we can't get these changes immediately into printed manuals. Hence, your manual may contain new change information on following pages.

A single change may affect several sections. Sections of the manual are often printed at different times, so some of the information on the change pages may already be in your manual. Since the change information sheets are carried in the manual until ALL changes are permanently entered, some duplication may occur. If no such change pages appear in this section, your manual is correct as printed.

TYPE 3S7/3T7

ELECTRICAL PARTS LIST AND SCHEMATIC CORRECTION

A1 3S7 VERTICAL Circuit Board Assembly

REPLACEABLE BY:

Q20 A, B 151-1041-00 (Replaceable by 151-1011-00)

CHANGE:

R195 308-0052-00 6 k Ω 5 W 5%

A3 3T7 SWEEP Circuit Board Assembly

ADD:

R337 315-0102-00 1 k Ω 1/4 W 5%

R343 315-0102-00 1 k Ω 1/4 W 5%

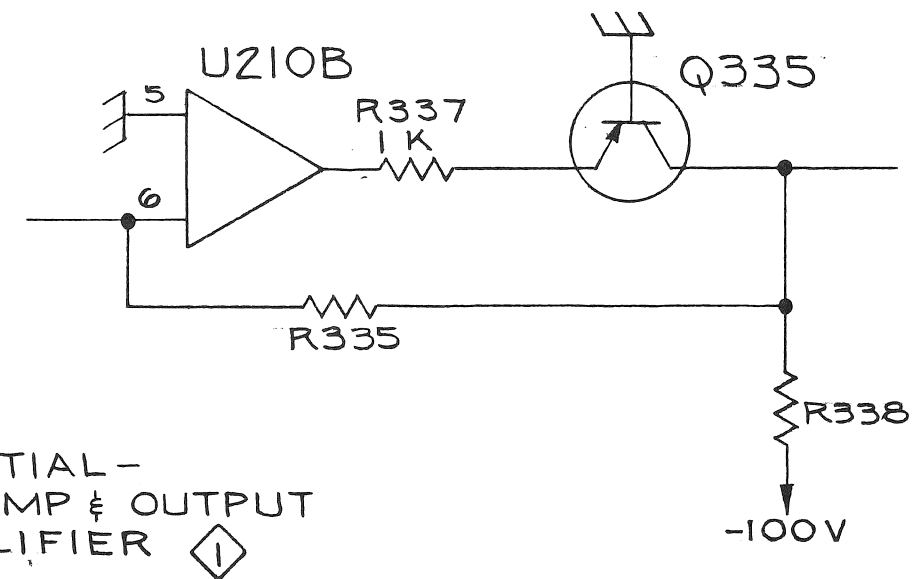

PARTIAL -
SLOW RAMP & OUTPUT
AMPLIFIER \diamond

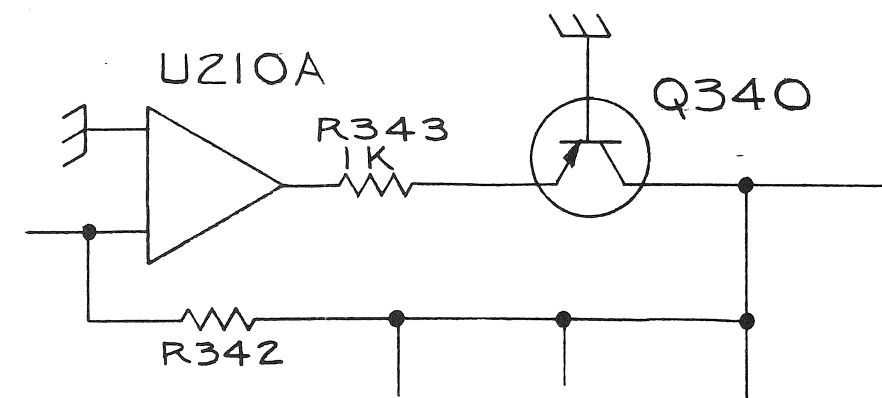

3T7

TENT SN B030000-up

ELECTRICAL PARTS LIST CORRECTION

	A3	3T7	SWEEP	Circuit Board Assembly
CHANGE TO:				
		670-1275-01		Complete Board
CR550	152-0153-00	Silicon		Tek Spec
CR552	152-0153-00	Silicon		Tek Spec
Q335	151-0164-00	Silicon	PNP TO-5	2N5447
Q550	151-0192-00	Silicon	NPN TO-92	Replaceable by MPS 6521
Q555	151-0192-00	Silicon	NPN TO-92	Replaceable by MPS 6521

3S7 TENT SN B040000-up

ELECTRICAL PARTS LIST AND SCHEMATIC CORRECTION

A1 3S7 VERTICAL

Circuit Board Assembly

CHANGE TO:

670-0964-01

Complete Board

C125

283-0119-00

.0022 μ F

Cer

200 V

3S7 EFF SN B050000-up

ELECTRICAL PARTS LIST AND SCHEMATIC CORRECTION

A1 VERTICAL Circuit Board Assembly

CHANGE TO:

670-0964-02 Complete Board

REMOVE:

R195 308-0052-00 6 k Ω 5 W WW 5%

ADD:

To outside of Bottom Transmission Line Section-

R195 308-0307-00 5 k Ω 3 W WW 1%

MECHANICAL PARTS LIST CORRECTION

SECTION 9

Page 9-2

CHANGE TO:

-33	670-0964-02	1	CIRCUIT BOARD ASSEMBLY-VERTICAL A1
-42	211-0116-00	2	SCREW, sems, 4-40 x 0.312 inch, PHB
	131-0157-00	2	TERMINAL, pin